

---

## INTRODUCTION TO PROGRAMMING

---

Introduction	5
Interfacing the HP 8510 System to a Controller	7
Inter-unit Cable Connections	7
Address Assignments	7
Programming Overview	9
Mnemonics	10
Numeric Entries and Units	10
Measurement Data	11
Communication with the Operator	13
Local Operation	13
System Status	13
Programming Examples	15
Meta Language Definition	16
HP-IB Instrument Control	16
Operator Interface	17
Other Program Control	17
Syntax Requirements	18
General HP-IB Programming	19
Interface Functions	19
Response to HP-IB Universal Commands	20
Response to HP-IB Addressed Commands	21
General Input Syntax	22
Marker Data Output	23
Active Function Output	25
Delta Marker Modes	26
Alternate Sweep	27
Read Marker in Dual Channel Modes	28
Using =MARKER	30

Trace Data Output	31
Transfer Trace Data to NWA Memory	34
Measurement Calibration	36
Using the Tape Cartridge	40
Hardcopy Output to Plotter	41
Hardcopy Output to Printer	41
Pass-Thru to System Bus Instruments:	
General Input/Output	42
Output to Printer	43
Output to Plotter	43
Using the HP 8510 Status Bytes	44
Read Status Bytes	44
Setting the Service Request Mask	46
Using the HP 8510 Learn String	47
User Display Graphics	49
Vector Diagrams	49
Text	51
Using the Tape to Store the User Display	52
Summary of User Graphics Statements	53
Summary of User Display Instructions	55
Example Program Listings	57

## ILLUSTRATIONS

Figure 1.	System Interconnections and HP-IB Addresses	6
Figure 2.	PA Vector Scaling	50
Figure 3.	Text Character Cell	51

## TABLES

Table 1.	Marker Units for all Display Formats	24
Table 2.	HP 8510 Status Bytes	45



## INTRODUCTION

This part of the HP 8510 network analyzer system manual, Introduction to Programming, explains how to automate network measurement and data processing operations using the HP 8510 system with an external controller via the Hewlett-Packard Interface Bus (HP-IB). Only programming is covered; familiarity with manual operation of the HP 8510 system is assumed, and details of how each function works are not given unless these are unique to programmed operation or are different for manual and programmed operation.

The first part of this Introduction to Programming is general, and it introduces the basic programmable capabilities of the HP 8510 network analyzer system. Sample program segments are discussed to show typical solutions to measurement and data processing problems. These can be adapted and developed to suit specific requirements.

The programming examples given are controller-independent. They are written in a simplified Meta Language in order to focus on the HP 8510 instrument control and data processing protocol rather than on language and controller requirements.

The BASIC program listing at the end presents all of the programming examples in a form that can be used with an HP 200 series computer as the external controller.

Programming mnemonics for all HP 8510 front panel controls and menu softkeys are given in the Reference Data part of this manual.

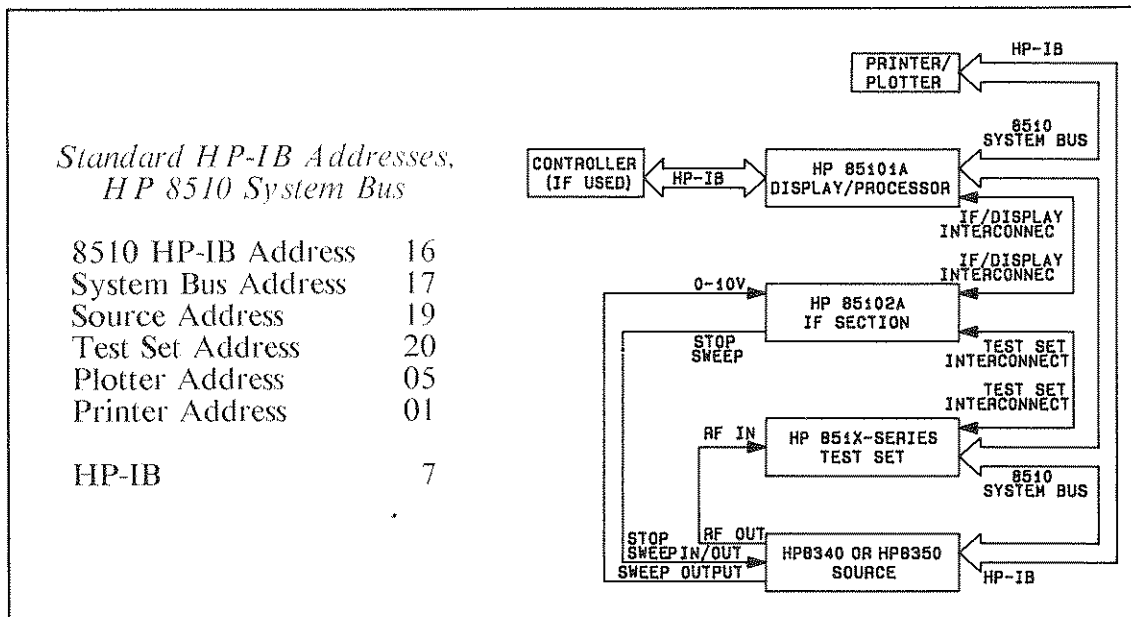

Figure 1. System Interconnections and HP-IB Addresses

## PROGRAMMING OVERVIEW

The HP 8510A network analyzer system, consisting of the HP 834x-series synthesized sweeper or HP 8350B/835xx-series source, the HP 851x-series test set, an HP-IB compatible printer and/or plotter, and the HP 8510 network analyzer, is a stand-alone system and does not require an external computer to perform a fully error-corrected measurement in the frequency or time domain. Its internal microprocessor controls the system instruments via the 8510 System Bus and computes all data internally.

However, an external controller can be connected to the 8510 HP-IB interface to provide complete external control of the system state, to transfer data to and from HP 8510 memory, to control instruments connected to the HP 8510 System Bus, and to use the HP 8510 CRT as a graphics display. These capabilities can extend the HP 8510 system features to provide detailed guidance of the measurement process, including interpretation of results, and saving of important data in external mass storage for computer-aided design and manufacturing applications.

Remote operation of the HP 8510 system is accomplished using the Hewlett-Packard Interface Bus, HP-IB, which is the Hewlett-Packard implementation of IEEE standard 488, dated 1978, and IEC 625-1. For technical information on the HP-IB, refer to the "Tutorial Description of the Hewlett-Packard Interface Bus," Part Number 5952-0156. Also see IEEE standard 728-1982, "IEEE Recommended Practice for Code and Format Conventions."

Use standard HP-IB protocol to program the system state using generally the same sequence as you press HP 8510 front panel hardkeys and softkeys. The controller is connected to the HP 8510 by a single interface bus. The system components are connected to the HP 8510 via the 8510 System Bus and are not linked directly to the controller. From the controller, the network analyzer system is treated as a single instrument, just as the various instruments that make up the system are controlled using the HP 8510 front panel.

For applications that require programming the system instruments directly, a Pass-Thru mode exists, in which the controller can communicate directly with an instrument on the HP 8510 System Bus without interpretation by the HP 8510 CPU. The next several pages present a general overview of programming features.





## MEASUREMENT DATA

Read measurement data over the HP-IB by outputting the current active marker value or by outputting a complete data trace. Required timing considerations are handled internally and, typically, measurement data is not presented until it is complete. The sequence

```
! RAMP Mode
"AVERON 16; NUMG 17; MARK 1; OUTPMARK;"
```

for operation in the Ramp sweep mode, or

```
! STEP Mode
"AVERON 16; NUMG 1; MARK 1; OUTPMARK;"
```

for operation in the Step sweep mode, turns averaging on, and commands that the necessary number of groups be taken. A group is the number of sweeps needed to make the measurement completely; thus the number of sweeps that make up a group depends on the calibration model being used and other details of the measurement. In the Ramp sweep mode, the number of groups needed to present a fully averaged trace is  $n + 1$ , where  $n$  is the averaging factor selected. In the Step sweep mode, the number of groups needed to present a fully averaged trace is 1. OUTPMARK readies the HP 8510 to output the trace value at the marker position.

The marker value is output as two ASCII numbers in the basic units for the selected display format. Use two real variables, for example,

```
Mag,Phase
```

to accept the data. If the marker value consists of a single value, as when **LOG MAG** (LOGM) or **PHASE** (PHAS) is selected, then the second value is set equal to zero.

The current value of the Active Function is read as a single ASCII number in the basic units for the quantity. The sequence

```
"MARK2; MARKMAXI; OUTPACTI;"
```

turns on Marker 2, moves the marker to the maximum value on the trace, then OUTPACTI readies the HP 8510 to output the current active function, which is the stimulus value at the marker position in this sequence. Use a single real variable, for example,

```
Freq
```

to accept the data.

A complete trace (block) of data can be read from network analyzer memory using

```
"FORM3; OUTPDATA;"
```

which prepares the HP 8510 to transfer trace data from the Corrected Data array for the currently selected channel. To read data, use a real array variable such as

```
Data(*)
```

where Data is the two-dimensional array (n elements by 2 elements where n is the current number of points selected) which receives the real/imaginary data pairs that make up the trace.

Trace data can be loaded into HP 8510 memory using

```
"FORM3; INPUDATA;"
```

which prepares the network analyzer to receive a data block and store the real/imaginary pairs into the selected channel corrected data array.

Raw, Corrected, Formatted, error coefficients, and trace math memory arrays can be selected for input/output. All transfers use IEEE 728 block transfer formats with EOI asserted with the last data byte.

## COMMUNICATION WITH THE OPERATOR

Messages to the operator of up to 50 characters may be displayed using

```
"TITL"MEASUREMENT NUMBER 1";
```

that causes the message MEASUREMENT NUMBER 1 to appear in the Title area of the HP 8510 CRT.

Text and graphics information may also be written to the CRT using a special area of HP 8510 memory, using an internal HP-GL subset or the standard plotting language implemented by the controller.

## LOCAL OPERATION

Return the HP 8510 to local control by pressing the front panel **LOCAL** key or by issuing the HP-IB command GTL 716 (HP Series 200 BASIC language LOCAL 716). After programming GTL 716, you must issue REN 7 (HP Series 200 BASIC language REMOTE 7) in order for the HP 8510 to accept data.

## SYSTEM STATUS

Important system status information is available by reading a two-byte status word, and by using other statements to interrogate specific functions. To further assist in program development, statements DEBUON (Debug On) and DEBUOFF (Debug Off) are used to control a network analyzer debug mode in which the instruction currently being executed is displayed in the Title area of the HP 8510 CRT.



## PROGRAMMING EXAMPLES

In a typical application, the system is set up for a particular measurement, appropriate measurement calibration is performed for each parameter to be measured, the test device is connected, its response is measured, and the data is output. When the test device is to be measured over several different frequency ranges, a separate calibration for each frequency range is performed. After connecting the device under test, recall the calibration set for each measurement sequence. Use the eight cal sets and the eight instrument state sets together to choose the appropriate instrument state for the measurement.

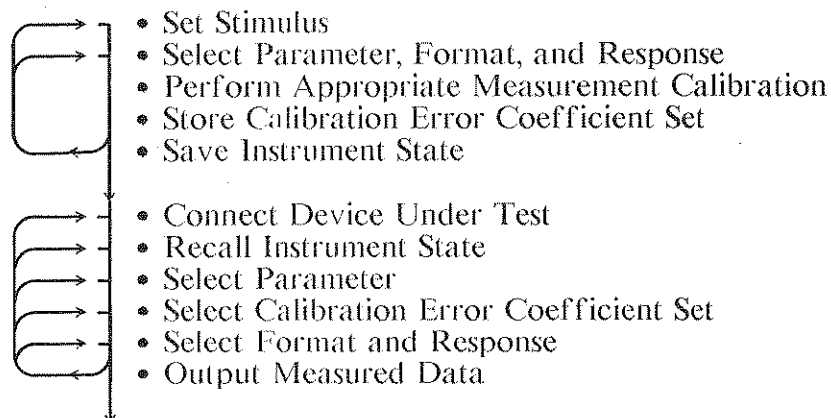

When you recall the instrument state, you select the complete stimulus, parameter, format, and response settings used during calibration. Select the parameter to be measured, turn correction On, then make the measurement. If you select an instrument state to which the current cal set does not apply, then correction is turned Off. Since recalling the calibration set recalls a limited instrument state consisting of important stimulus settings, if the appropriate parameter is already selected it is only necessary to recall the calibration set in order to achieve the correct instrument state for measurement.

## META LANGUAGE DEFINITION

Programming examples given in this discussion use generalized statement structures in order to be controller independent.

**HP-IB INSTRUMENT CONTROL.** Communication with the HP 8510 over the HP-IB is shown using the following statement structures:

Listen Nwa; "mnemonic [value]; ... "

Talk Nwa\_data; variable; ...

Listen Nwa\_systbus; "instrument syntax ... "

Talk Nwa\_systbusdata; variable; ...

The term Listen represents the controller language program statement that commands the addressed instrument to listen for and accept data transmission from the controller. The term Talk represents the controller language program statement that commands the addressed instrument to transmit data to the controller. For example, Listen and Talk correspond to BASIC Language statements OUTPUT and ENTER, respectively.

The symbols Nwa, Nwa\_data, Nwa\_systbus, and Nwa\_systbusdata specify input/output path assignments. These correspond to I/O paths created using BASIC language ASSIGN @Nwa TO statements. Nwa and Nwa\_data designate the standard HP 8510 HP-IB programming address, typically 716 if the controller addresses the HP-IB as address 7, and the standard 8510 HP-IB address of 16 is selected. Nwa\_systbus and Nwa\_systbusdata represent the HP 8510 System Bus programming address used for the pass-thru mode, typically 717.

The term mnemonic represents the HP 8510 program code to command the function. Spaces are not allowed in the mnemonic construction. If alpha or numeric input is allowed for the function, then it follows the mnemonic, shown here by the term [value] in which the brackets indicate an optional entry, which may be a pre-assigned variable or a literal. Mnemonics that command an active function are followed by a value if you intend to change the value of the function.

The term variable represents a simple or complex numeric or string variable which accepts data from the HP 8510. The term instrument syntax represents program codes used in the Pass-Thru mode that have the form required by the specific system instrument on the HP 8510 system bus being programmed.

**OPERATOR INTERFACE.** During the execution of the example program the following statement structure is used to request an input from the operator:

```
Input "message";variable
```

The term message is displayed to instruct the operator that some action is required (make a connection or enter a value) before program execution can continue. The term variable represents a program variable; it will accept a value that the operator enters using the controller keyboard. If you are using an HP Series 200 controller, the LINPUT statement is used for this purpose.

**OTHER PROGRAM CONTROL.** Other statements used in the example programs include:

```
Goto label
```

which represents a simple program branch to the specified label;

```
If expression Then label
```

which represents a conditional branch based on the true or false evaluation of the expression;

```
For variable = constant1 To constant2 By constant3
```

```
·  
·
```

```
Next variable
```

which represents a controlled loop in which the statements between the For and the Next statements are repeated  $(\text{constant2}-\text{constant1})/\text{constant3}$  times; and

```
! remark
```

where remark is explanatory information for the programmer.

**SYNTAX REQUIREMENTS**

Mnemonics may be written using all uppercase characters (as in STAR, preferred), or using initial uppercase followed by lowercase (as in Star, allowed).

No spaces may be embedded in a mnemonic. Spaces are allowed between a mnemonic and a value, and between a value and its units.

Use the semicolon (;) to separate instructions. Use the comma (,) to separate each value in a series.

If no units terminator follows the value for frequency and time units, the system defaults to HP 8510 Basic Units (Hz, seconds). Other quantities (power, length) do not use a units terminator. The following units terminators may be used:

FREQUENCY		TIME	
Giga	GHz	basic units	s
Mega	MHz	milli	ms
kilo	kHz	nano	ns
basic units	Hz	micro	us
		femto	fs

These units terminators may be uppercase or lowercase characters.



## GENERAL HP-IB PROGRAMMING

After the HP-IB REMOTE command is issued, addressing the HP 8510 using an appropriate Listen statement causes the HP 8510 to enter the Remote mode in which the front panel hardkeys and softkeys, except for the LOCAL key, are locked out. After the initial Listen statement, either Talk or Listen statements will be accepted.

Pressing the LOCAL key restores front panel control functions until the next Listen command is received. Programming the Local Lockout command, LLO, locks out the front panel completely, even the LOCAL key. Issue the HP-IB LOCAL command to cancel Local Lockout.

If the HP 8510 is already addressed as a listener, a GTL 716 (LOCAL 716) sets the HP 8510 system to the normal manual mode without changing the current instrument state.

All HP-IB Universal and Addressed Commands and the HP 8510 system response to the commands are listed below. Controller-specific considerations are discussed in the Example Program Listings later in this Introduction to Programming, where specific controllers and languages are considered.

**INTERFACE FUNCTIONS.** The following identification codes for the interface functions indicate the HP 8510 HP-IB interface capability. For more information, refer to the "Tutorial Description of the HP-IB." HP Part No 5952-0156.

SH1	Source Handshake: Full Capability.
AH1	Acceptor Handshake: Full Capability.
T6	Talker: Basic Talker, Serial Poll.
TE0	No Extended Talker.
L4	Listener: Basic Listener.
LE0	No Extended Listener.
SR1	Service Request: Full Capability.
RL1	Remote/Local: Complete Capability.
PP0	No Parallel Poll Capability.
DC1	Device Clear: Full Capability.
DT1	No Device Trigger Capability.
C0	No Controller Capability.
E1	Driver Electronic: Open Collector.

**RESPONSE TO HP-IB UNIVERSAL COMMANDS.** The HP 8510 HP-IB responds to the following universal commands from an external controller at any time regardless of whether or not it is addressed. Refer to the language reference manual of the controller being used to find the corresponding commands allowed by the controller.

- DCL    Device Clear: Clears HP 8510 status, no change in instrument state, system is ready to accept HP-IB commands and data.
- LLO    Local Lockout: Disables the HP-IB front panel LOCAL button. GTL to clear.
- SPD    Serial Poll Disable: Disables the Serial Poll mode over the HP 8510 HP-IB.
- SPE    Serial Poll Enable: Enables the Serial Poll mode over the HP 8510 HP-IB.
- PPU    Parallel Poll Unconfigure: The HP 8510 system does not respond.

**RESPONSE TO HP-IB ADDRESSED COMMANDS.** The HP 8510 HP-IB responds to the following addressed commands when it is addressed as a listener. Refer to the language reference manual of the controller being used to find the corresponding commands allowed by the controller.

**GET** Group Execute Trigger: The HP 8510 system, already in the triggered data acquisition mode, initiates the pre-programmed action of continuing the data acquisition process.

**GTL** Go To Local: Returns the HP 8510 system to local control.

Following GTL, the HP 8510 HP-IB will respond only to HP-IB Universal and Addressed Commands, not to HP-IB data. Issue REN to enable data transfer using controller Listen and Talk commands.

**REN** Remote Enable. Enable all HP-IB command and data functions.

**SDC** Selected Device Clear: Clears HP 8510 status, no change to instrument state, system is ready to accept instructions and data.

The HP 8510 system does not respond to the following Addressed Commands.

**PPC** Parallel Poll Configure.

**TCT** Take Control.

## GENERAL INPUT SYNTAX

This example can help you become familiar with the HP 8510 HP-IB instructions. It allows you to type an HP 8510 instruction and have it sent to the HP 8510 for execution. Refer to the Example Program Listings at the end of this Introduction to Programming section for the Example 1 program that is executable on your controller.

```
! Example 1  Input Syntax Familiarization
Start: !
Input "Type 8510 command"; String$
Listen Nwa; String$
Goto Start
```

The Input statement displays a message, then waits for an input (type the string and then press controller CONTINUE). Using a simple program like this one, you can input commands one at a time and observe the network analyzer response. At first, try instructions such as

```
STAR 10 GHz;
```

because the change in instrument state can easily be observed. Refer to the menu structures in the Reference Data section to see the syntax required for operation of each programmable function.

You may enter a sequence of instructions by separating each instruction with the semicolon (;), as follows.

```
STAR 2 GHz; STOP 10 GHz; CHAN2; LINP;
```

The HP 8510 instruction DEBUON causes all HP 8510 instructions to be displayed in the Title area of the HP 8510 CRT. The last 30 characters in the instruction queue are displayed, with the most recently received instruction at the left of the area, pushing instructions higher on the queue off of the area to the right. This means that the currently executing command may not be visible if the queue is over 30 characters in length. Use the HP 8510 instruction DEBUOFF to disable display of the command queue.

If the network analyzer does not recognize the mnemonic, or cannot execute it in the correct sequence, then HP-IB activity stops and the instruction in error is displayed in the Title area of the HP 8510 CRT. Press HP 8510 LOCAL, then continue operation, or issue an HP-IB DCL or SDC (run the example program from the beginning).

Commands are executed in the sequence in which they are received by the HP 8510. When a command is received, it is syntax checked, stored on the command queue, then executed. Some commands, such as SING, free the processor for other tasks during the time that they are executing. If time becomes available while such a command is executing, the process of reading a command, syntax checking, storage in the command queue, and sometimes overlapping execution continues until up to eight commands are stored for pending execution.

### MARKER DATA OUTPUT

If the system is currently operating in either the HOLD or the CONTINUAL mode (see STIMULUS menu), then the data is output immediately; if SINGLE, or NUMBER OF GROUPS has been selected, then the data output operation waits until the specified number of sweeps is complete. For example, the sequence

```
! Example 2 Marker Data Output (Ramp Mode)
Listen Nwa; "LINP; AVERON 16;"
Listen Nwa;"NUMG 17; MARK1; MARKMAXI; OUTPMARK;"
Talk Nwa__Data;Mag,Phase
```

selects the linear magnitude polar display, turns on averaging, and commands 17 groups of sweeps. When complete, marker 1 is turned on, moved to the maximum trace value, then the marker value is assigned to the variables Mag and Phase.

The OUTPMARK statement always transfers two values in standard ASCII format. As shown in Table 1, the values depend upon the currently selected display format. Two values are output in every display format, but for cartesian displays the second value is zero.

Data taken in the Step mode requires only one group of sweeps (NUMG 1) because each data point is averaged before the next point is measured.

To move the marker to a specific stimulus value, include a numeric value in the instruction. The sequence

```
Listen Nwa;"MARK1 9.123456789 GHz; OUTPMARK;"
Talk Nwa__data;Mag, Phase
```

moves marker 1 to the data point closest to 9.123456789 GHz, then transfers the marker value.

Table 1. Marker Units for all Display Formats

FORMAT	MARKER Basic Units	OUTPMARK A, B VALUE
LOG MAG	dB	dB, 0
PHASE	degrees (°)	degrees, 0
DELAY	seconds (s)	seconds, 0
SMITH CHART	$R \pm jX (\Omega)$	ohms, ohms
SWR	(unitless)	SWR, 0
LINEAR MAGNITUDE	$\rho$ (unitless) (reflection)	lin mag, 0
	$\tau$ (unitless) (transmission)	lin mag, 0
LIN mkr on POLAR	$\rho \angle \phi^\circ$ (reflection)	lin mag, degrees
	$\tau \angle \theta^\circ$ (transmission)	lin mag, degrees
LOG mkr on POLAR	dB $\angle \phi^\circ$	log mag, degrees
Re/Im mkr on POLAR	$x \pm jy$ (unitless)	real, imag
INVERTED SMITH	$G \pm jB$	Siemens, Siemens
REAL	$x$ (unitless)	real, 0
IMAGINARY	$jy$ (unitless)	real, 0

## ACTIVE FUNCTION OUTPUT

The value of the current Active Function is output as a single ASCII value in the basic units of the function. For example,

```
! Example 3 Active Function Output
Listen Nwa:"OUTPACTI;"
Talk Nwa:Freq
```

when executed with a marker as the active function, such as following Example 2, returns the frequency in Hertz at the marker position.

The sequence AVERON then OUTPACTI outputs the currently selected averaging factor. The sequence ELED then OUTPACTI returns the currently selected Electrical Delay value in seconds.

The title and various other user-defined labels can also be read over the HP-IB by making it the active function, then reading the characters into a string variable. For example,

```
Listen Nwa:"TITL; OUTPTITL;"
Talk Nwa;String$
```

returns the current title as the active function. Note that the title, cal kit, standard class, standard, or user parameter label instructions do not include any quotation marks for this application.

## DELTA MARKER MODES

The delta marker functions are programmed in the same way as the buttons are pressed in a manual procedure. For example, the sequence

```
! Example 4 Peak-to-Peak Measurement
Listen Nwa;"MARK2; MARKMAXI; DELR2; MARK1;
  MARKMINI; OUTPMARK;"
Talk Nwa_data;Mag,Phase
Listen Nwa;"OUTPACTI"
Talk Nwa_data;Freq
Listen Nwa;"DELO; MARKOFF"
```

moves Marker 2 to the maximum trace value, selects the delta marker mode with Marker 2 as the reference marker, moves Marker 1 to the maximum trace value, then outputs the difference between Marker 2 and Marker 1. Then the delta mode is turned off, and the markers are turned off.



**ALTERNATE SWEEP**

This example of dual-channel operation sets up an alternate sweep.

```
! Example 5  Alternate Sweep
Listen Nwa;"UNCC;"
Listen Nwa;"CHAN1; STAR 2 GHz; STOP 5 GHz;"
Listen Nwa;"CHAN2; STAR 3 GHz; STOP 4 GHz;"
Listen Nwa;"SPLI;"
```

Uncoupled channels is selected, the Channel 1 and Channel 2 frequency sweeps are set, then the dual-channel split display mode is selected.

## READ MARKER VALUES IN DUAL CHANNEL MODES

To read marker values in dual-channel display modes, first select the Channel, as in

```
! Example 6 Dual Channel Read Marker
Listen Nwa:"MARK1 3.5 GHz;"
Listen Nwa:"CHAN1; SING; AUTO; OUTPMARK;"
Talk Nwa __data:Mag.Phase
Listen Nwa:"CHAN2; SING; AUTO; OUTPMARK;"
Talk Nwa __data:Mag.Phase
```

The SING instruction (take single group of sweeps) or the NUMG instruction following channel selection, parameter change, or domain change, ensures that the trace has been updated and the data is ready to be read. After SING or NUMG the network analyzer is placed in the HOLD mode. It is generally best to select the hold mode for data output. Use the CONT (CONTINUAL) instruction to restart the sweep.

When 2-port error correction is On and the network analyzer is in HOLD, it is not necessary to take a sweep to update the display when the parameter selection is changed. This is because raw data for all parameters is available. In all other situations, when the parameter selection is changed, it is necessary to take at least one group of sweeps to assure current data.

Note that if the system is in Hold, the parameter is changed, and raw data is not available, then the raw data array is initialized to the equivalent of measured data equal to 0.0 at every data point. If LOG MAG is selected, the marker magnitude value will be approximately -700 dB. The raw data array and trace will be updated at the completion of the next group of sweeps.

In general, timing considerations are handled automatically and data is not presented until it is valid. The SING and NUMG instructions hold off execution of the instruction which follows until the specified number of groups is complete. The output instructions (OUTPMARK, OUTPRAW<sub>n</sub>, OUTPDATA, OUTPFORM, OUTPMEMO, and OUTPCALC<sub>n</sub>), and AUTO, MARKMAXI, MARKMINI, and EQUA (=MARKER), are held off until all preceding instructions are complete. For example, in the sequence

```
"TIMB; OUTPDATA;"
```

the instruction TIMB performs a time domain conversion, which requires about 1 second. Execution of OUTPDATA is delayed until the conversion is complete. Thus, the data which is output is the actual converted data.

However, if multiple instrument state changes are input sequentially and the programmer wishes to assure that a particular instruction has completed its execution before the next instruction is executed, the programmer can control the holdoff using the HP 8510 WAIT instruction. WAIT is used at any time you wish to make certain that all preceding instructions have completed before the instruction which follows WAIT begins execution.

## USING =MARKER

Use of the =MARKER function to measure deviation from linear phase is shown in the following example.

```
! Example7 Using =MARKER
Listen Nwa;"CHAN2; PHAS; ELED 0;"
Listen Nwa;"DELA; SING; CONT; ELED; EQUA; PHAS;"
```

The sequence selects Channel 2, sets Electrical Delay to 0 seconds, selects DELAY, commands a group of sweeps to ensure that the data is current, returns to continuous sweep mode, sets Electrical Delay equal to the marker value, and then selects the PHASE display. Upon completion, the phase trace should will be flat if the marker value is representative of the phase slope over the sweep.

In all =MARKER applications, the current marker value becomes the value of the current active function. Valid functions for use with =MARKER are START, STOP, CENTER, SPAN, REF VALUE, ELECTRICAL DELAY, PHASE OFFSET, and PORT EXTENSIONS.

## TRACE DATA OUTPUT

Complete traces may be read from various HP 8510 memory locations using the following instructions.

OUTPFORM;	read from selected channel Formatted data array,
OUTPDATA;	read from selected channel Corrected data array,
OUTPRAW1;	read from selected channel $S_{11}$ Raw data array,
OUTPRAW2;	read from selected channel $S_{21}$ Raw data array,
OUTPRAW3;	read from selected channel $S_{12}$ Raw data array, and
OUTPRAW4;	read from selected channel $S_{22}$ Raw data array.

These statements prepare the network analyzer to output trace data for the currently selected channel at the HP 8510 HP-IB.

Data in the Formatted array is the same as data in the Corrected data array except that the Formatted data has trace math and smoothing applied.

OUTPDATA and OUTPRAW $n$  output data in real/imaginary pairs regardless of the currently selected display format.

For cartesian displays, OUTPFORM selects data output in the basic units of the current FORMAT with the imaginary part zero, as for OUTPMARK (refer to Table 1 LOG MAG, PHASE, DELAY, SWR, LINEAR MAGNITUDE, REAL, and IMAGINARY). If a polar, Smith, or Inverted Smith FORMAT is selected, data is output in real/imaginary pairs.

The assignments listed above for the raw data arrays are valid only when 2-port error correction is turned on. If uncorrected, response-only, or 1-port error-corrected is displayed, then only RAW1 for the currently selected channel holds valid data.

A trace currently stored in one of the four trace math memories may be output by selecting the memory, using

DEFM1;	to select Memory 1,
DEFM2;	to select Memory 2,
DEFM3;	to select Memory 3, or
DEFM4;	to select Memory 4.

Turn on memory by issuing a DISPMEMO instruction, then use

OUTPMEMO;	to read currently selected memory.
-----------	------------------------------------

This transfers the memory data in real/imaginary pairs.

The IEEE 728 data block transfer format transfers is selected by the following mnemonics:

FORM4	ASCII floating point format (ASCII strings separated by comma),
FORM1	HP 8510 internal Binary format (6 bytes/point),
FORM2	IEEE 32 bit floating point format (8 bytes/point),
FORM3	IEEE 64 bit floating point format (16 bytes/point).

After PRESET the FORM1 format, HP 8510 internal binary, is selected.

FORM1, FORM2, and FORM3 select output formats in which the data is transferred in a sequence consisting of a preamble, #A; an ASCII integer, Size (two bytes), which gives the total number of bytes to be transferred; and pairs of real/imaginary numbers. The total number of pairs that are output corresponds to the number of points currently selected.

FORM3 is the standard internal format for HP 9000 Series 200 controllers and is the typical method used in the examples here. FORM1 is useful for fast transfer of traces between the HP 8510 and the controller, but it should not be used where further processing of the trace data by the controller is required.

FORM4 provides standard ASCII transfers like those used for OUTPMARK and does not use the Preamble or Size variables. The total number of pairs that are output corresponds to the number of points currently selected.

This example shows the data transfer to the controller when FORM3 is selected.

```
! Example 8 Trace Data Output
Listen Nwa; "FORM3; NUMG 1; OUTPDATA"
Talk Nwa_Data; Preamble, Size, Data(*)
```

Use NUMG or SING to synchronize data output with completion of data acquisition. The variable Preamble accepts the #A block header, the variable Size accepts the value representing the total number of data bytes in the block, and Data(\*) accepts the real/imaginary data pairs.

If Data(\*) is dimensioned to less than the number of points currently selected, then the controller will probably terminate the talk operation when the receiving array is full. If Data(\*) is dimensioned to less than the number of points currently selected, then the talk operation will not terminate and you may issue another talk statement to read the remaining data, or send another HP 8510 command (such as ENTO;) to terminate the HP 8510 data output mode. Since the Size variable can be used to determine the length of the block transfer, Preamble and Size may be read and then used to dynamically allocate the required data array storage.

Note that all transfers use standard IEE 728 block transfer formats with EOI asserted with the last byte of data.

## TRANSFER TRACE DATA TO NWA MEMORY

Trace data may be loaded into network analyzer memory while in HOLD or CONTINUOUS modes. When HOLD is selected, completion of a data input operation initiates a data processing cycle in which the displayed trace is updated to reflect the new data. The following mnemonics

INPUFORM;	load into selected channel Formatted data array,
INPUDATA;	load into selected channel Corrected data array,
INPURAW1;	load into selected channel $S_{11}$ Raw data array,
INPURAW2;	load into selected channel $S_{21}$ Raw data array,
INPURAW3;	load into selected channel $S_{12}$ Raw data array, and
INPURAW4;	load into selected channel $S_{22}$ Raw data array,

prepare the network analyzer to transfer data pairs at the HP 8510 HP-IB to the specified array for the currently selected channel.

INPUDATA and INPURAW $n$  expect data in real/imaginary pairs regardless of the currently selected display format.

For cartesian displays, INPUFORM expects data in the basic units of the current FORMAT with the imaginary part zero, as for OUTPFORM (refer to Table 1 LOG MAG, PHASE, DELAY, SWR, LINEAR MAGNITUDE, REAL, and IMAGINARY). If a polar, Smith, or Inverted Smith FORMAT is selected, data is expected in real/imaginary pairs.

The assignments listed above for the raw data arrays are valid only when 2-port error correction is turned on. If uncorrected, response-only, or 1-port error-corrected is displayed, then only RAW1 for the currently selected channel should be loaded.

Select the trace memory to be loaded using

DEFM1;	select Memory 1,
DEFM2;	select Memory 2,
DEFM3;	select Memory 3, or
DEFM4;	select Memory 4,

then

INPUDATA; DATA;

to load data into the Corrected data array and store the data into the selected memory.

The data format for these transfers is selected by the FORM1, FORM2, FORM3, and FORM4 mnemonics as for the OUTP instructions. One of the FORM $n$  instructions should precede each transfer.



This example shows the data transfer from the controller to HP 8510 Corrected data array for the currently selected channel using FORM3.

```
! Example 9 Trace Data Input
Listen Nwa; "HOLD; FORM3; INPUDATA;";
Listen Nwa; Preamble, Size, Data(*)
```

HOLD prevents overwriting the data just input with data from the next group of sweeps. The variable Preamble holds the #A block header, the variable Size holds the value representing the total number of data bytes in the block, and Data(\*) holds the real/imaginary data pairs.

The HP 8510 will accept data until the specified number of bytes is received, or EOI is detected, then terminate the listen mode. If the number of data bytes is not equal to the value of the variable Size, the message "BLOCK INPUT ERROR" is displayed. If the value of the variable size does not correspond to the current number of points selected, then the message "BLOCK INPUT LENGTH ERROR" is displayed. If more than the internally allocated number of bytes are input, then these bytes are treated like regular commands, which will most likely cause a syntax error. If less than the specified number of bytes are input without an EOI, you may continue with another Listen statement.

When using FORM 4, always suppress the CR/LF which would normally terminate the Listen statement that sends the INPU instruction as follows.

```
Listen Nwa; "HOLD; FORM4; INPUDATA;";
Listen Nwa; Data(*)
```

The semicolon following the last quote mark is used in BASIC to suppress the normal CR/LF sent at the end of the statement. Failure to suppress this character results in the HP 8510 accepting the CR/LF as the first data byte.

## MEASUREMENT CALIBRATION

This example shows a sequence for accomplishing an  $S_{11}$  1-Port calibration and an  $S_{21}$  frequency response calibration under program control. Refer to the Cal menu structure in Reference Data.

```

! Example 10 S11 1-Port and S21 Response Cals
Listen Nwa; "S11; CALI; CALIS11;"
Input "Port 1, connect open, then press CONTINUE."
Listen Nwa; "CLASS11A;" ! (Open circuit data measured.)
Input "Port 1, connect short, then press CONTINUE."
Listen Nwa; "CLASS11B;" ! (Short circuit data measured.)
Listen Nwa; "CLASS11C;" ! (Uses both LOWBAND and SLIDING.)
Input "Port 1 connect fixed load, then press CONTINUE."
Listen Nwa; "STANC;" ! (Lowband Fixed load data measured.)
Input "Port 1, connect sliding load, then press CONTINUE."
Listen Nwa; "STANB;" ! (Select Sliding Load)
Input "Move element to first index mark, then press CONTINUE."
Listen Nwa; "SLIS;" ! (Sliding Load Data Measured)
For Slide= 2 to 6
Input "Move element to next index mark, then press CONTINUE."
Listen Nwa; "SLIS;" ! (Sliding Load Data Measured)
Next Slide
Listen Nwa; "SLID; DONE; SAV1; CALS1;"
! (Error coefficients computed and stored;
! Cal Menu displayed with CORRECTION ON.)
! Corrected S11 trace displayed.
Listen Nwa;"S21;"
Input "Connect Thru, then press CONTINUE."
Listen Nwa;"CALI; CALIRESP; STANC; DONE; CALS2;"
! (Error coefficients computed and stored;
! Cal Menu displayed with CORRECTION ON.)
! Corrected S21 trace displayed.
Input "Connect Device Under Test, then press CONTINUE."
Listen Nwa;"S11; SING;"
! (S11 data displayed)
Listen Nwa;"S21; SING;"
! (S21 data displayed)

```

During measurement, when the parameter is changed, the cal set which was last turned On for that parameter is recalled and applied to the measurement.

The measurement calibration sequence is performed under program control using the same procedure as manually. First select the calibration kit using CAL1 or CAL2, then select the type of calibration to be performed using:

Select Calibration Type

<u>Mnemonic</u>	<u>Cal Type</u>
CALIRESP;	RESPONSE
CALIS11;	S <sub>11</sub> 1-PORT
CALIS22;	S <sub>22</sub> 1-PORT
CALIFUL2;	FULL 2-PORT
CALIONE2;	ONE-PATH 2-PORT

The RESPONSE measurement calibration always consists of a single standard class. If a single standard is assigned to the class, then CALIRESP causes a Measurement Restart and the standard is measured. The message WAIT--MEASURING CAL STANDARD appears while the measurement is being made. The speed of the measurement depends on the mode (Ramp or Step) selected and the number of averages. If multiple standards are assigned to the class, then the standard to be measured must be selected using STANA through STANG. All other calibration types consist of multiple standard classes.

Since the Standard Class labels are user-definable, a special mnemonic is used to select measurement of each standard class.

#### Select Standard Class

<u>Mnemonic</u>	<u>Example Standard Class Labels</u>
CLASS11A;	S <sub>11</sub> OPEN (1 <sup>st</sup> S <sub>11</sub> standard class)
CLASS11B;	S <sub>11</sub> SHORT (2 <sup>nd</sup> S <sub>11</sub> standard class)
CLASS11C;	S <sub>11</sub> LOADS (3 <sup>rd</sup> S <sub>11</sub> standard class)
CLASS22A;	S <sub>22</sub> OPEN (1 <sup>st</sup> S <sub>22</sub> standard class)
CLASS22B;	S <sub>22</sub> SHORT (2 <sup>nd</sup> S <sub>22</sub> standard class)
CLASS22C;	S <sub>22</sub> LOADS (3 <sup>rd</sup> S <sub>22</sub> standard class)
FWDT;	FORWARD TRANSMISSION THRU
FWDM;	FORWARD MATCH THRU
REVT;	REVERSE TRANSMISSION THRU
REVM;	REVERSE MATCH THRU
FWDI;	FORWARD ISOLATION
REVI;	REVERSE ISOLATION

If a single standard is assigned to the class, then any of these causes a Measurement Restart and the standard is measured. The message WAIT--MEASURING CAL STANDARD appears while the measurement is being made. The speed of the measurement depends on the mode (Ramp or Step) selected and the number of averages.

If two or more standards are assigned to the class (up to seven standards may be assigned to a class), then the standard to be measured is selected using the STANA through STANG instructions.

#### Select Calibration Standards in Class

<u>Mnemonic</u>	<u>Example Standard Labels</u>	
	(S <sub>11</sub> and S <sub>22</sub> LOADS)	(RESPONSE)
STANA;	BROADBAND	OPEN
STANB;	SLIDING	SHORT
STANC;	LOWBAND	THRU
STAND;	(not used)	(not used)
STANE;	(not used)	(not used)
STANF;	(not used)	(not used)
STANG;	(not used)	(not used)

Any of these causes a Measurement Restart and the standard is measured. The message WAIT--MEASURING CAL STANDARD appears while the measurement is being made. The speed of the measurement depends on the mode (Ramp or Step) selected and the number of averages.

Issue DONE; when the necessary standards in the class are measured. The CAUTION 25 message "ADDITIONAL STANDARDS NEEDED" is displayed if the standards thus far measured do not cover the current frequency range.

The SAV*;;* instruction initiates final error coefficient computation. Finally, issue CALS*;;* to specify the cal set to receive the error coefficients. Correction is turned on for the parameters covered by the cal set; for both channels if Coupled Channels is selected, or for the current channel if Uncoupled Channels is selected.

## USING THE TAPE CARTRIDGE

The HP 8510 tape cartridge mass storage can be use to great advantage in large tests by providing capacity to store instrument states (INSS*n*), cal sets (CAL*S**n*), calibration kits (CALK*n*), and trace data (DATAFORM*n*). Refer to the Tape Menu in Reference Data for a more complete list of mnemonics.

```
! Example 11 Tape Cartridge Store and Load
Input "Insert Tape Cartridge",Input$
Input "Initialize Tape Cartridge? (Enter Y or N)",Input$
If Input$="Y" Then Listen Nwa;"INIT"
!
Listen Nwa;"STOR; INSS1; FILE1"
Listen Nwa;"CHAN1; STOR; DATAFORM; FILE1"
Listen Nwa;"CHAN2; STOR; DATAFORM; FILE2"
Listen Nwa;"STOR; MEMO1; FILE1"
Listen Nwa;"STOR; CALS1; FILE1"
Listen Nwa;"STOR; CALK1; FILE1"
Listen Nwa;"DIRE"
! View directory on HP 8510 CRT display
```

Load the network analyzer memory from the tape cartridge as follows:

```
Listen Nwa;"HOLD"
Listen Nwa;"LOAD; INSS1; FILE1"
Listen Nwa;"CHAN1; LOAD; DATAFORM; FILE1"
Listen Nwa;"CHAN2; LOAD; DATAFORM; FILE2"
Listen Nwa;"DISPDATA; LOAD; MEMO1; FILE1"
Listen Nwa;"CORROFF; LOAD; CALS1; FILE1"
Listen Nwa;"LOAD; CALK1; FILE1"
```

If HOLD is not programmed, the formatted data traces would be overwritten by new data during the next sweep.

Note that in order to use DATAFORM, DATARAW, or DATADATA, the channel to which the data applies must be selected. When loaded, the trace is automatically updated. DATARAW stores information on the tape from the Raw data array for the currently displayed parameter on the currently selected channel, or, if 2-Port correction is turned on, all four raw data arrays for the selected channel.

To load a memory trace, the memory display must be off (DISPDATA). Correction must be off (CORROFF) before cal sets can be loaded into HP 8510 memory from tape.

## HARDCOPY OUTPUT TO PLOTTER

Measurement results are output to a plotter connected to the HP 8510 System Bus using a sequence of commands to specify the quadrant on the paper, the pen color, and the data to be plotted. The following sequence plots the four S-parameters.

```
! Example 12 Plots Using COPY Menu
Input "Load Paper, then CONTINUE"
Listen Nwa;"S11; SING; LEFU; PLOTALL"
Listen Nwa;"S21; SING; LEFL; PLOTALL"
Listen Nwa;"S12; SING; RIGU; PLOTALL"
Listen Nwa;"S22; SING; RIGL; PLOTALL"
```

PLOTALL causes the entire screen, except the Menu, to be plotted. Other commands to specify the part of the screen to be plotted and the pen color may be used.

## HARDCOPY OUTPUT TO PRINTER

The printer connected to the 8510 System Bus may be used in the same way as in manual operation. The instruction

```
! Example 13 List Trace Values
Listen Nwa;"LIST"
```

uses the LIST TRACE VALUES function to output the list of trace values to the printer.

**PASS-THRU TO SYSTEM BUS INSTRUMENTS:  
GENERAL INPUT/OUTPUT**

The HP 8510 uses a pass-thru technique to allow the external controller to communicate directly with instruments on the HP 8510 System Bus. All pass-thru exchanges are handled in the same way. First designate the device on the 8510 System Bus to receive/send the data using the ADDRPASS instruction and the two digit HP 8510 System Bus address of the instrument, then Talk/Listen to the 8510 System Bus address. To send data, use

```
Listen Nwa:"ADDRPASS nn;"  
Listen Nwa_systbus;"instrument specific syntax"
```

where *nn* is the address of the device on the HP 8510 system bus which is to receive the data, and "instrument specific syntax" is the instructions and data sent to the instrument.

If the instrument is instructed to output data, then use

```
Talk Nwa_systbusdata; String$
```

to receive the data, where String\$ is dimensioned to accept the ASCII string sent from the device. Note that if the device on the system bus does not terminate its output with the CR/LF, then it is the responsibility of the programmer to terminate the Talk operation.

The specified pass-thru address remains in effect until changed by the programmer. Instructions and data may be sent to the HP 8510 HP-IB address or to the HP 8510 System Bus address in any sequence. When the HP 8510 System Bus is addressed, an automatic System Bus 'Local' is issued which halts all system bus activity and places the HP 8510 in Hold. When the HP 8510 HP-IB is addressed following a pass thru, an automatic System Bus 'Remote' is issued which returns control of the system bus to the HP 8510.

The addressed device cannot handshake to the controller or respond to HP-IB Universal or Addressed commands via the system bus.



## OUTPUT TO PRINTER

You may print directly to the printer using the Pass-Thru mode as follows.

```
! Example 14 Print to Printer on 8510 System Bus
Listen Nwa;"ADDRPASS 01;" ! Printer's System Bus address is 01
PRINTER IS 717           ! (Nwa_systbus)
PRINT "MEASUREMENT NUMBER 1"
```

This example begins with the HP 8510 instruction ADDRPASS 01 that sets the state in which data addressed to 717 (the 8510 System Bus address) is passed-thru to the device at address 01 on the 8510 System Bus. Next, a controller-specific command, HP 9000 Series 200 in this example, specifies the hardcopy device as the printer at address 717. Finally, the controller-specific hardcopy output statement outputs the message. The string is accepted at the HP 8510 System Bus address 717 and passed-thru to the printer.

## OUTPUT TO PLOTTER

Likewise, you may plot directly to an HP-IB digital plotter on the system bus as follows.

```
! Example 15 Plot to Plotter on HP 8510 System Bus
Listen Nwa;"ADDRPASS 05;"
PLOTTER IS 717, HPGL
.
. Controller HPGL Plotting statements
.
```

The HP 8510 instruction ADDRPASS 05 routes data received at HP 8510 System Bus address 717 to the plotter at address 05 on the HP 8510 System Bus. Next, the controller-specific command PLOTTER IS specifies the plotter is be the device at address 717. Controller-specific plotting statements generate the HPGL data to be plotted.

## USING THE HP 8510 STATUS BYTES

Table 2 shows bit assignments of the HP 8510 Primary and Secondary status bytes. These bits are set according to the current instrument state of the HP 8510 system.

Important HP 8510 instructions relating to the status word are:

- OUTPSTAT: Prepare the HP 8510 to output the status word as two ASCII numbers, 0 to 255. Completion clears the status word to 0,0.
- CLES: Clear status bytes to 0,0; clear SRQ.
- SRQM a,b: Send two integer ASCII values, 0 to 255 to set the Service Request Mask. Power On, TEST, and PRESET clear the Service Request Mask to 0,0.

## READ STATUS BYTES

Both status bytes are read using a sequence such as

```
! Example 16 Read HP 8510 Status Bytes
Listen Nwa;"OUTPSTAT;"
Talk Nwa _data; Primary,Secondary
```

where Primary and Secondary are variables to receive the value of each byte. You may read the status bytes in separate Talk operations.

After the Power Up sequence is complete, bit 2 of the Extended status byte is set, making the value of OUTPSTAT 0,4.

Table 2. HP 8510 Status Bytes

PRIMARY STATUS BYTE (#1)				
Bit #	7	6	5	4
Decimal Value	128	64	32	16
Function	Reason in Extended Byte	RQS (SRQ issued)	Syntax Error	SING, NUMG, complete
Bit #	3	2	1	0
Decimal Value	8	4	2	1
Function	One-Path 2-Port Measurement. Wait for GET after REVERSE DEVICE.	TRIG Mode, Waiting for GET (next point or sweep)	Data Entry Complete	CAUTION Message Displayed

EXTENDED STATUS BYTE (#2)				
Bit #	7	6	5	4
Decimal Value	128	64	32	16
Function				
Bit #	3	2	1	0
Decimal Value	8	4	2	1
Function		Power ON Sequence Complete	Key Pressed	

## SETTING THE SERVICE REQUEST MASK

After Power ON, TEST, and PRESET, the HP 8510 SRQ mask is set to 0,0 and no changes in the Primary or Secondary status byte will generate an SRQ. To enable generation of an SRQ when one or more of the status bits changes from 0 to 1 (changes from cleared to set), specify the SRQ mask to sense the change in status. Using the HP 8510 SRQM instruction, send two bytes, each having a value from 0 to 255, as follows.

```
! Example 17 Setting HP 8510 SRQ Mask  
Listen Nwa;"SRQM 16,0;"
```

This will cause the HP 8510 to generate an SRQ when bit 4 of the Primary Status byte changes from 0 to 1.

Detect and service the SRQ according to the controller protocol. Normal completion of a service cycle clears the HP 8510 status bytes to 0,0 and does not change the SRQ mask.

Examples in the Example Program Listings show various interrupt service routines.

## USING THE HP 8510 LEARN STRING

The HP 8510 Learn String is a binary coded string which describes the current instrument state. This string may be read from the HP 8510 to controller memory via the HP-IB, then it may be loaded back into HP 8510 memory in order to reset the system to the state represented by the string. This learn string is transferred using internal HP 8510 binary format (FORM 1), and it is not intended that the user attempt to decode or modify the string.

The commands

OUTPLEAS;    Output Learn String to HP-IB,  
 INPULEAS;    Input Learn String from HP-IB;  
                   Set the HP 8510 controls to that state,

control transfer of the string. The contents of the learn string is identical to the information processed by the SAVE and RECALL features for HP 8510 internal storage, and the TAPE STORE and LOAD Instrument State functions for the HP 8510 tape cartridge.

The following example shows a sequence to transfer the learn string. The learn string is 3400 bytes in length and can be read into an integer type array of length 1700.

```
! Example 17 Transfer HP 8510 Learn String
dim Integer Learn_string (1700)
Listen Nwa:"OUTPLEAS;"
Talk Nwa_data:Preamble, Size, Learn_string (*)
! Preamble = #A
! Size = 3400
.
.
.
Listen Nwa:"INPULEAS;"
Listen Nwa:Preamble, Size, Learn_string (*)
```

OUTPLEAS and INPULEAS select FORM 1 data format transfers. The data is transferred in a sequence beginning with the Preamble, #A; an integer size, having the value 3400 for the Learn String; followed by 3400 bytes of HP 8510 internal binary format data which represents the control state of the HP 8510, with EOI asserted on the last byte.



## USER DISPLAY GRAPHICS

Vector diagrams and Text can be written to a reserved area of the HP 8510 CRT display memory via the HP 8510 system bus using either an HP-GL subset internal to the HP 8510, or the standard controller language graphics commands. This reserved graphics area is output using PLOTALL; and may be recorded using tape USED;

### VECTOR DIAGRAMS

A vector diagram consists of a PA, Plot Absolute, display instruction followed by any number of x,y integer pairs.

```
! Example 18 Plot Absolute Using HP 8510 HP-GL Subset
Listen Nwa:"ADDRPASS 31"
Listen Nwa_systbus:"CS; PU"
Listen Nwa_systbus:"PA 128,384; PD; PA 3328,384, 3328,3584,
128,3584 128,384"
```

ADDRPASS 31 sets up the Pass-Thru mode in which data sent to the 8510 System Bus address, 717, is routed to the User Display area of the HP 8510 CRT display memory. The CS instruction clears the screen. The PU instruction lifts the pen, causing the following PA instruction to draw a blank vector. The PD, Pen Down, causes the following PA instruction to draw a visible line. The PA, Plot Absolute, instruction is followed by the coordinates for the other three corners of the box.

The plotting area of the HP 8510 CRT is:

x = 0 to 4095

y = 0 to 4095

Figure 2 shows internal scaling for PA vector diagrams.

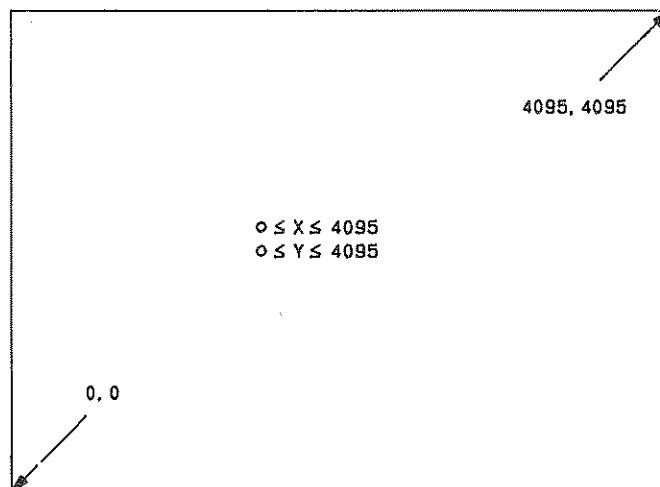

Figure 2. PA Vector Scaling

To increase the intensity of the vector, draw it multiple times as shown in controller-specific examples at the end of this section.

The PR, Plot Relative, instruction moves the pen from its present position to the new position  $x,y$  units away.

```
! Example 18A Plot Relative
Listen Nwa;"ADDRPASS 31"
Listen Nwa_systbus;"CS; PU"
Listen Nwa_systbus;"PA 128,384; PD; PR 3200,0, 0,3200, -3200,0,
0,-3200"
```

This outlines the Menu labels area.



**TEXT**

Position standard ASCII text on the screen by addressing the text location with a PA or PR vector. Text between the LB mnemonic and the end of text character, CTRL C, is displayed beginning at the character cell position of the current vector. Figure 3 shows the 64 by 128 element character cell which encloses the 48 by 64 element character image area. Part of Example 18 in the Example Program Listings demonstrates the use of the LB instruction.

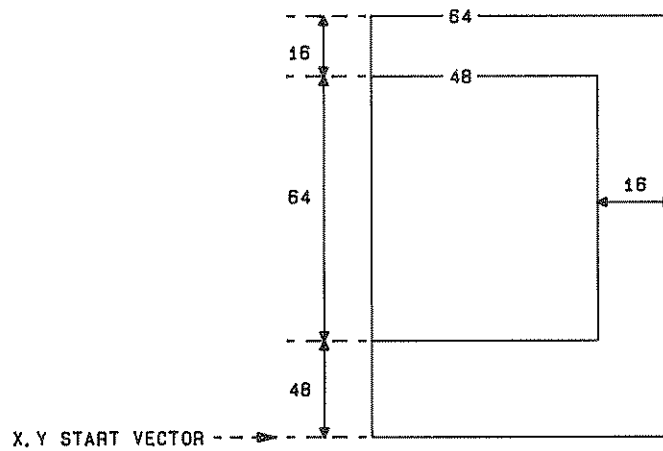

*Figure 3. Text Character Cell*

**USING THE TAPE TO STORE THE USER DISPLAY**

By storing the User Display on the HP 8510 internal tape cartridge, the vector diagrams and text can be recalled for display even if the controller is disconnected from the HP 8510. For example:

```
Listen Nwa;"STOR; USED; FILE1"
```

stores the vector and text data presently in user display memory in User Display File 1.

The User Display graphics may be loaded from tape using

```
Listen Nwa;"LOAD; USED; FILE1"
```

which erases the current User Display, then loads and displays the previously stored graphics and text.

## SUMMARY OF USER GRAPHICS STATEMENTS

The following statements are used to control plotting of vectors and text into the HP 8510 User Display area of internal memory.

- PA  $\downarrow x1,y1$  Plot Absolute vector. Move the pen from the current location to the location specified by the following x,y pair. Any number of x,y pairs may follow the PA instruction; each number must be separated from the previous number by a comma.  
 $0 < x < 4095; 0 < y < 4095.$
- PR  $\downarrow x1,y1$  Plot Relative vector. Move the pen from the current location to the relative position specified by the following x,y pair. Any number of x,y pairs may follow the PR instruction; each number must be separated from the previous number by a comma.  
 $0 < x < 4095; 0 < y < 4095.$
- PD Pen Down. When followed by a PA or PR instruction, this instruction will cause a visible vector to be drawn to the new location.
- PU Pen Up. When followed by a PA or PR instruction, this instruction will cause a blank vector to be drawn to the new location.
- LB  $\downarrow \text{ASCII char} \mid \text{ctx}$  Label Text. The ASCII characters following the LB command are drawn on the CRT beginning in the character cell at the current vector position. The string must be terminated with the end-of-text character, CNTRL C.
- DF Set to Default state (PU, PA).



```

2410 !
2420 PRINT N;Real;Imag;
2430 PRINT N;Mag;Phase
2440 !
2450 NEXT N
2460 !
2470 PRINT "Compare Re/Im and LIN mkr values."
2480 !
2490 RETURN
2500 !
2510 Example9: ! Trace Data Input *****
2520 !
2530 PRINT "Input Trace Data."
2540 OUTPUT @Nwa;"HOLD; FORM3; INPUDATA;"
2550 OUTPUT @Nwa_data2;Preamble,Size,Data(*)
2560 !
2570 RETURN
2580 !
2590 Example10: ! S11 1-PORT AND S21 RESPONSE CALIBRATIONS *****
2600 !
2610 PRINT "S11 1-Port Measurement Calibration."
2620 !
2630 OUTPUT @Nwa;"CHAN1; S11; CORROFF; CAL1; CALIS111;"
2640 LINPUT "Port 1, Connect Shielded Open, then press CONTINUE",Input$
2650 OUTPUT @Nwa;"CLASS11A;" ! (Shielded Open Circuit Data Measured)
2660 LINPUT "Port 1, Connect Short, then press CONTINUE",Input$
2670 OUTPUT @Nwa;"CLASS11B;" ! (Short Circuit Data Measured)
2680 OUTPUT @Nwa;"CLASS11C;" ! (Uses Both LOWBAND and SLIDING)
2690 LINPUT "Port 1, Connect Fixed Load, then press CONTINUE",Input$
2700 OUTPUT @Nwa;"STANC;" ! (LOWBAND Load Data Measured)
2710 LINPUT "Port 1, Connect Sliding Load, then press CONTINUE",Input$
2720 OUTPUT @Nwa;"STANB;" ! (Select Sliding Load)
2730 LINPUT "Move Element to First Index Mark, then press CONTINUE",Input$
2740 OUTPUT @Nwa;"SLIS;" ! (Sliding Load Data Measured)
2750 FOR Slide=2 TO 6
2760     LINPUT "Move Element to Next Index Mark, then press CONTINUE",Input$
2770     OUTPUT @Nwa;"SLIS;" ! (Sliding Load Data Measured)
2780 NEXT Slide
2790 DISP "Remove Sliding Load."
2800 OUTPUT @Nwa;"SLID; DONE; SAV1; CALS1;"
2810 ! (Error coefficients computed and stored;
2820 ! Cal Menu displayed with CORRECTION ON;
2830 ! Corrected S11 trace displayed.)
2840 !
2850 LINPUT "Press CONTINUE",Input$
2860 !
2870 PRINT "S21 Response Measurement Calibration."
2880 !
2890 OUTPUT @Nwa;"CHAN2; S21; CORROFF; CAL1; CALIRESP;"
2900 LINPUT "Connect Thru, then press CONTINUE",Input$
2910 OUTPUT @Nwa;"STANC;" ! (Thru Data Measured)
2920 OUTPUT @Nwa;"DONE; CALS2;"
2930 ! (Vector frequency response computed and stored;
2940 ! Cal Menu displayed with CORRECTION ON;
2950 ! Corrected S21 trace displayed.)
2960 !
2970 LINPUT "Press CONTINUE".Input$
2980 !
2990 PRINT "Measure S11 and S21."
3000 !

```



```

3610 OUTPUT @Nwa;"S22; SING; PEN4; RIGL; PLOTALL;"
3620 !
3630 RETURN
3640 !
3650 Example13: ! TRACE LIST TO PRINTER *****
3660 !
3670 PRINT "List Trace Values."
3680 OUTPUT @Nwa;"LINP; POIN51; SING; LIST;"
3690 !
3700 RETURN
3710 !
3720 Example14: ! PRINT TO PRINTER ON 8510 SYSTEM BUS *****
3730 !
3740 PRINT "Print Title via Pass-Thru."
3750 OUTPUT @Nwa;"ADDRPASS 01;"
3760 PRINTER IS 717 ! (Nwa_systbus)
3770 PRINT
3780 PRINT "MEASUREMENT NUMBER 1"
3790 PRINT
3800 !
3810 RETURN
3820 !
3830 Example15: ! PLOT USER GRAPHICS USING HP-GL SUBSET *****
3840 !
3850 Plot absolute: !
3860 PRINT "Plot User Graphics."
3870 OUTPUT @Nwa;"ADDRPASS 31;"
3880 OUTPUT @Nwa_systbus;"CS; PU;"
3890 FOR N=1 TO 5
3900 OUTPUT @Nwa_systbus;"PA 128,384; PD; PA 3328,384, 3328,3584, 128,3584"
3910 NEXT N
3920 OUTPUT @Nwa_systbus;"PU; PA 2000,2000; PD; LBSINGLE CHANNEL;"
3930 LINPUT "Press CONTINUE",Input$
3940 OUTPUT @Nwa_systbus;"PU;"
3950 FOR N=1 TO 5
3960 OUTPUT @Nwa_systbus;"PA 128,1184; PD; PA 1728,1184, 1728,2784, 128,2784"
3970 NEXT N
3980 OUTPUT @Nwa_systbus;"PU; PA 2000,1872; PD; LBDUAL, CHANNEL 1;"
3990 LINPUT "Press CONTINUE",Input$
4000 OUTPUT @Nwa_systbus;"PU;"
4010 FOR N=1 TO 5
4020 OUTPUT @Nwa_systbus;"PA 1760,1184; PD; PA 3360,1184, 3360,2784, 1760,2784"
4030 NEXT N
4040 OUTPUT @Nwa_systbus;"PU; PA 2000,1744; PD; LBDUAL, CHANNEL 2;"
4050 LINPUT "Press CONTINUE",Input$
4060 OUTPUT @Nwa_systbus;"PU;"
4070 FOR N=1 TO 5
4080 OUTPUT @Nwa_systbus;"PA 3424,2; PD; PA 4092,2, 4092,4092, 3424,4092"
4090 NEXT N
4100 OUTPUT @Nwa_systbus;"PU; PA 2000,1616; PD; LBMENU AREA;"
4110 OUTPUT @Nwa_systbus;"PU;"
4120 !
4130 LINPUT "Turn On Measurement Display: Press CONTINUE",Input$
4140 !
4150 OUTPUT @Nwa_systbus;"RS;"
4160 !
4170 LINPUT "Show Split Display: Press CONTINUE",Input$
4180 !
4190 OUTPUT @Nwa;"SPLI;"

```

```

4200 !
4210 LINPUT "Store User Display on Tape: Press CONTINUE",Input$
4220 PRINT "Store User Display."
4230 OUTPUT @Nwa;"STOR; USED; FILE1;"
4240 !
4250 LINPUT "Turn Off Measurement Display: Press CONTINUE",Input$
4260 OUTPUT @Nwa_systbus;"CS;"
4270 !
4280 LINPUT "Erase User Display: Press CONTINUE",Input$
4290 OUTPUT @Nwa_systbus;"PG;"
4300 !
4310 LINPUT "Turn On Measurement Display: Press CONTINUE",Input$
4320 OUTPUT @Nwa_systbus;"RS;"
4330 !
4340 LINPUT "Load User Display from Tape: Press CONTINUE",Input$
4350 PRINT "Load User Display."
4360 OUTPUT @Nwa;"LOAD; USED; FILE1;"
4370 !
4380 LINPUT "Next Example: Press CONTINUE",Input$
4390 !
4400 OUTPUT @Nwa_systbus;"PG; RS;"
4410 !
4420 RETURN
4430 !
4440 Example16: ! PLOT USING BASIC HP-GL *****
4450 !
4460 OUTPUT @Nwa;"ADDRPASS 31;"
4470 PLOTTER IS 717,"HPGL"
4480 WINDOW 0,4095,0,4095
4490 !
4500 ! HP-GL PLOTTING STATEMENTS
4510 !
4520   FRAME
4530   MOVE 100,100
4540   DRAW 3995,3995
4550   MOVE 3995,100
4560   DRAW 100,3995
4570 !
4580 OUTPUT @Nwa;"PLOTALL;"
4590 !
4600 PRINT "Press HP 8510 ENTRY OFF to abort Plot."
4610 LINPUT "Press CONTINUE",Input$
4620 !
4630 OUTPUT @Nwa;"ADDRPASS 31;"
4640 OUTPUT @Nwa_systbus;"PG; RS;"
4650 RETURN
4660 !
4670 Example17: ! STORE ERROR COEFFICIENT DATA, PROCESS DATA, LOAD DATA
4680 !
4690 Read response: !
4700 PRINT "Read Cal Coefficients."
4710 OUTPUT @Nwa;"S21; CORR0N; CALS2; FORM3; OUTPCALCO1;"
4720 ENTER @Nwa_data2;Preamble,Size,Data(*)
4730 !
4740 FOR N=0 TO 200
4750   Formatted_data(N,0)=Data(N,0)
4760   Formatted_data(N,1)=Data(N,1)
4770 NEXT N
4780 !
4790 PRINT "Store Processed Cal Coefficients."

```



```

4800 OUTPUT @Nwa;"CORROFF; CAL1; CALIRESP; FORM3; INPUCALCO1;"
4810 OUTPUT @Nwa_data2;Preamble,Size,Formatted_data(*)
4820 OUTPUT @Nwa;"SAVC; CALS2; CONT; CORRON; CALS2;"
4830 !
4840 PRINT "Correction On."
4850 LINPUT "Press CONTINUE",Input$
4860 !
4870 Read_1_port: !
4880 !
4890 PRINT "Reading and Plotting Directivity Coefficient."
4900 OUTPUT @Nwa;"HOLD; S11; CORRON; CALS1; FORM3; OUTPCALCO1;"
4910 ENTER @Nwa_data2;Preamble,Size,Data(*)
4920 !
4930 OUTPUT @Nwa;"CORROFF; FORM3; INPUDATA;"
4940 OUTPUT @Nwa_data2;Preamble,Size,Data(*)
4950 OUTPUT @Nwa;"AUTO; DEBUOFF; TITL"DIRECTIVITY PLOT";"
4960 LINPUT "Press CONTINUE",Input$
4970 !
4980 PRINT "Reading and Plotting Source Mismatch Coefficient."
4990 OUTPUT @Nwa;"DEBUON; S11; CAL1; CORRON; CALS1; FORM3; OUTPCALCO2;"
5000 ENTER @Nwa_data2;Preamble,Size,Data(*)
5010 !
5020 OUTPUT @Nwa;"CORROFF; FORM3; INPUDATA;"
5030 OUTPUT @Nwa_data2;Preamble,Size,Data(*)
5040 OUTPUT @Nwa;"AUTO; DEBUOFF; TITL"SOURCE MISMATCH PLOT";"
5050 LINPUT "Press CONTINUE",Input$
5060 !
5070 PRINT "Reading and Plotting Relection Tracking Coefficient."
5080 OUTPUT @Nwa;"DEBUON; S11; CAL1; CORRON; CALS1; FORM3; OUTPCALCO3;"
5090 ENTER @Nwa_data2;Preamble,Size,Data(*)
5100 !
5110 OUTPUT @Nwa;"CORROFF; FORM3; INPUDATA;"
5120 OUTPUT @Nwa_data2;Preamble,Size,Data(*)
5130 OUTPUT @Nwa;"AUTO; DEBUOFF; TITL"REFLECTION TRACKING PLOT";"
5140 !
5150 RETURN
5160 !
5170 Example18: ! MODIFY CAL KIT (TYPICAL X-BAND WAVEGUIDE) *****
5180 !
5190 PRINT "Define New Cal Kit."
5200 LINPUT "Insert Initialized Data Tape Cartridge, then CONTINUE",Input$
5210 OUTPUT @Nwa;"STOR; CALK2; FILE2;"
5220 PRINT "Old Cal Kit 2 now on File 2."
5230 !
5240 PRINT "Defining New Cal Kit."
5250 OUTPUT @Nwa;"MODI2; DEFS 1; STDTSHOR;"
5260 OUTPUT @Nwa;"OFFD 0.018652 ns; OFFL 0; OFFZ 50;"
5270 OUTPUT @Nwa;"MINF 6.557 GHz; MAXF 999 GHz;"
5280 OUTPUT @Nwa;"WAVE; LABS"XSHORT 1"; STDD;"
5290 !
5300 OUTPUT @Nwa;"DEFS 2; STDTSHOR;"
5310 OUTPUT @Nwa;"OFFD 0.055957 ns; OFFL 0; OFFZ 50;"
5320 OUTPUT @Nwa;"MINF 6.557 GHz; MAXF 999 GHz;"
5330 OUTPUT @Nwa;"WAVE; LABS"XSHORT 2"; STDD;"
5340 !
5350 OUTPUT @Nwa;"DEFS 3; STDTLOAD;"
5360 OUTPUT @Nwa;"OFFD 0; OFFL 0; OFFZ 50; MINF 6.557 GHz; MAXF 999 GHz;"
5370 OUTPUT @Nwa;"FIXE; WAVE; LABS"XLOAD"; STDD;"
5380 !
5390 OUTPUT @Nwa;"DEFS 11; STDTDELA;"

```

```

5400 OUTPUT @Nwa;"OFFD 0; OFFL 0; OFFZ 50; MINF 6.557 GHz; MAXF 999 GHz;"
5410 OUTPUT @Nwa;"WAVE; LABS"XTHRU"; STDD;"
5420 !
5430 OUTPUT @Nwa;"SPECS11A 1; CLAD; SPECS11B 2; CLAD; SPECS11C 3; CLAD;"
5440 !
5450 OUTPUT @Nwa;"LABES11A"1/8 SHORT";"
5460 OUTPUT @Nwa;"LABES11B"3/8 SHORT";"
5470 OUTPUT @Nwa;"LABES11C"STDXL";"
5480 !
5490 OUTPUT @Nwa;"SPECS22A 1; CLAD; SPECS22B 2; CLAD; SPECS22C 3; CLAD;"
5500 !
5510 OUTPUT @Nwa;"LABES22A"1/8 SHORT";"
5520 OUTPUT @Nwa;"LABES22B"3/8 SHORT";"
5530 OUTPUT @Nwa;"LABES22C"STDXL";"
5540 !
5550 OUTPUT @Nwa;"SPECFWDT 11; CLAD; SPECREVT 11; CLAD;"
5560 OUTPUT @Nwa;"SPECFWDM 11; CLAD; SPECREVM 11; CLAD;"
5570 OUTPUT @Nwa;"SPECRESP 1, 2, 11; CLAD;"
5580 !
5590 OUTPUT @Nwa;"LABEFWDT" THRU "; LABEREVT" THRU ";"
5600 OUTPUT @Nwa;"LABEFWDM" THRU "; LABEREVM" THRU ";"
5610 OUTPUT @Nwa;"LABERESP"RESPONSE";"
5620 !
5630 OUTPUT @Nwa;"LABK" X BAND ";"
5640 OUTPUT @Nwa;"KITD;"
5650 !
5660 OUTPUT @Nwa;"STOR; CALK2; FILE3;"
5670 PRINT "New Cal Kit now on File 3."
5680 !
5690 LINPUT "Reload Old cal kit? (Y/N)",Input$
5700 IF Input$="N" THEN RETURN
5710 OUTPUT @Nwa;"LOAD; CALK2; FILE2;"
5720 PRINT "Old Cal Kit 2 Reloaded."
5730 !
5740 RETURN
5750 !
5760 Example19: ! REDEFINE PARAMETER *****
5770 !
5780 OUTPUT @Nwa;"USER3; DRIVPORT2; LOCKA2; REDD;"
5790 LINPUT "USER 3 Redefine Done - Press CONTINUE",Input$
5800 OUTPUT @Nwa;"SAVE1;"
5810 PRINT "Redefined USER 3 now Saved in INST STATE 1."
5820 !
5830 ! PRESET selects standard User parameter definition.
5840 ! RECALL selects previously saved user parameter definitions.
5850 !
5860 RETURN
5870 !
5880 Example20: ! READ AND OUTPUT CAUTION/TELL MESSAGE *****
5890 !
5900 LINPUT "Press CONTINUE to Read HP 8510 Caution/Tell",Input$
5910 !
5920 OUTPUT @Nwa;"OUTPERRO;"
5930 ENTER @Nwa_data1;Error_number,Input$
5940 PRINT Error_number,Input$
5950 !
5960 LINPUT "ANOTHER? (Y/N)",Input$
5970 IF Input$="Y" OR Input$="y" THEN GOTO Example20
5980 RETURN
5990 !

```

```

6000 Example21: ! READ AND OUTPUT STATUS BYTES *****
6010 !
6020 LINPUT "Press CONTINUE to Read HP 8510 Status",Input$
6030 !
6040 OUTPUT @Nwa;"OUTPSTAT;"
6050 ENTER @Nwa_data1;Bytea,Byteb
6060 PRINT Bytea,Byteb
6070 !
6080 LINPUT "ANOTHER? (Y/N)",Input$
6090 IF Input$="Y" OR Input$="y" THEN GOTO Example21
6100 RETURN
6110 !
6120 !
6130 Wait_loop: GOTO Wait_loop
6140 !
6150 Example22: ! OUTPUT KEY CODE *****
6160 !
6170 DISP "PRESS HP 8510 Front Panel Key. (f5 to EXIT.)"
6180 !
6190 OUTPUT @Nwa;"DEBUON; CLES; SRQM 128,2"
6200 ON INTR 7 GOSUB Key_code
6210 ENABLE INTR 7;2
6220 ON KEY 5 LABEL "NEXT EXAMPLE" GOTO Exit_example22
6230 GOTO Wait_loop
6240 !
6250 Exit_example22: !
6260             DISABLE INTR 7
6270             OFF KEY 5
6280             PRINT ""
6290             RETURN
6300 !
6310 Key_code:   !
6320             Ser_poll=SPOLL(@Nwa)
6330             OUTPUT @Nwa;"OUTPKEY"
6340             ENTER @Nwa_data1;A
6350             PRINT A;
6360             ENABLE INTR 7
6370             RETURN
6380             !
6390 Example23: ! TRIG Mode, TRIGGERED DATA ACQUISITION *****
6400 !
6410 LINPUT "CONTINUE to start Triggered sweep. (f5 to exit.)",Input$
6420 !
6430 OUTPUT @Nwa;"CLES; SRQM 4,0"
6440 ON INTR 7 GOTO Next_point
6450 ENABLE INTR 7;2
6460 Points=0
6470 OUTPUT @Nwa;"STEP; TRIG;"
6480 GOTO Wait_loop
6490 !
6500 Exit_example23: !
6510             DISABLE INTR 7
6520             RETURN
6530 !
6540 Next_point: !
6550             Ser_poll=SPOLL(716)
6560             IF Points=201 THEN GOTO End_of_sweep
6570             TRIGGER 716
6580             Points=Points+1
6590             PRINT Points;

```

```

6600             ENABLE INTR 7
6610             GOTO Wait_loop
6620      !
6630 End_of_sweep: !
6640             OFF INTR 7
6650             PRINT "END OF SWEEP"
6660             OUTPUT @Nwa;"RAMP; FRER;"
6670             OUTPUT @Nwa;"CLES; SRQM 0,0"
6680             LINPUT "ANOTHER? (Y/N)",Input$
6690             IF Input$="Y" OR Input$="y" THEN GOTO Example23
6700             GOTO Exit_example23
6710      !
6720 Example24: ! GET Triggered Sweep, Reverse Device During ONE-PATH 2-PORT ***
6730      !
6740      ! This example only operates when ONE-PATH 2-PORT correction
6750      ! is turned on using a Reflection/Transmission test set.
6760      RETURN ! Eliminate this line to run example
6770      LINPUT "Connect Device Under Test, then CONTINUE. (f5 to exit).",Input$
6780      Forward=1
6790      !
6800      ON KEY 5 LABEL "NEXT EXAMPLE" GOTO Exit_example24
6810      OUTPUT @Nwa;"CLES; SRQM 8,0"
6820      ON INTR 7 GOTO Next_sweep
6830      ENABLE INTR 7;2
6840      GOTO Wait_loop
6850      !
6860 Next_sweep:  !
6870             IF Forward=1 THEN GOTO Trig
6880             LINPUT "Reverse Device then CONTINUE.",Input$
6890 Trig:        Ser_poll=SPOLL(716)
6900             TRIGGER 716
6910             IF Forward=0 THEN GOTO Example24
6920             Forward=0
6930             ENABLE INTR 7
6940             GOTO Wait_loop
6950      !
6960 Exit_example24: !
6970             DISABLE INTR 7
6980             OFF KEY 5
6990             DISP
7000             RETURN
7010      !
7020 Example25: ! WAIT Required *****
7030      !
7040      ON KEY 5 LABEL "NEXT EXAMPLE" GOTO Exit_example25
7050      !
7060      M=.000000001
7070      OUTPUT 716;"PRES; REIP; SING; DATI; DISPMATH;"
7080      OUTPUT 716;"ELED 0 s;"
7090      FOR N=0 TO 1 STEP M
7100      OUTPUT 716;N;" s;"
7110      OUTPUT 716;"WAIT;"
7120      NEXT N
7130      !
7140 Exit_example25: !
7150             OFF KEY 5
7160             RETURN
7170      !
7180 Example26: ! WAIT Not Required (holdoff included in OUTPxxxx) *****
7190      !

```

```
7200 ON KEY 5 LABEL "NEXT EXAMPLE" GOTO Exit_example26
7210 !
7220 OUTPUT @Nwa;"STAR 1 GHz; STOP 15 GHz; S11; LINP; S21; LOGM;"
7230 !
7240 Restart26: !
7250 Param=1
7260 Read marker: !
7270 IF Param=1 THEN OUTPUT 716;"S11; SING; AUTO;"
7280 IF Param=2 THEN OUTPUT 716;"S21; SING; AUTO;"
7290 OUTPUT 716;"MARK1"
7300 FOR N=1 TO 15 STEP (14/201)*10
7310 OUTPUT 716;N;" GHz;"
7320 OUTPUT 716;"OUTPACTI;"
7330 ENTER 716;Freq
7340 OUTPUT 716;"OUTPMARK;"
7350 ENTER 716;Mag,Phase
7360 PRINT Freq,Mag,Phase
7370 NEXT N
7380 IF Param=2 THEN GOTO Restart26
7390 Param=2
7400 GOTO Read_marker
7410 !
7420 Exit_example26: !
7430 OFF KEY 5
7440 RETURN
7450 !
7460 END
```



---

**CIRCUIT MODELING PROGRAM**

---

Introduction	3
Hardware Requirements	5
Load and Execute CMP	6
Commands and Statements	7
Commands	7
Statements	7
Editing Commands and Statements	7
Help	7
Examples	8
RCL Example	8
Lossy Transmission Line Example	12
Two-Port Stepped Impedance Standard Example	17
Command and Statement Reference	21
CMP Program Statements	21
CMP Commands	21
CMP Statement Syntax	22
Commands	27
Replacement Parts	29

## ILLUSTRATIONS

Figure 1.	RCL Example Schematic Diagram	8
Figure 2.	RCL Example $S_{11}$ Frequency Domain Response	9
Figure 3.	RCL Example $S_{21}$ Frequency Domain Response	10
Figure 4.	RCL Example $S_{11}$ Time Domain Response	11
Figure 5.	Lossy Transmission Line Schematic Diagram	12
Figure 6.	Lossy Transmission Line $S_{11}$ Frequency Domain Response	13
Figure 7.	Lossy Transmission Line $S_{11}$ Time Domain Response	14
Figure 8.	Lossy Transmission Line $S_{11}$ Frequency Domain Response with Shunt Loss Added	15
Figure 9.	Lossy Transmission Line $S_{11}$ Time Domain Response with Shunt Loss Added	16
Figure 10.	Two-Port Stepped Impedance Standard	17
Figure 11.	Two-Port Stepped Impedance Standard $S_{11}$ Frequency Domain Response	19
Figure 12.	Two-Port Stepped Impedance Standard $S_{11}$ Frequency Domain Response	19



## INTRODUCTION

This part of the HP 8510 network analyzer system manual explains how to use the Circuit Modeling Program (CMP) that runs on an HP Series 200 computer controlling an HP 8510 network analyzer system with the time domain Option 010. The Circuit Modeling Program is designed to show you what simple circuits look like in the frequency and time domains.

Hardware requirements, program loading, statements, and commands are discussed first. Then three example circuits are discussed, showing CRT displays that you can expect to see: an RCL circuit, a lossy transmission line, and a two-port stepped impedance standard. Lists of CMP program statements and commands are given at the end.



## CIRCUIT MODELING PROGRAM

The HP 8510 network analyzer system Circuit Modeling Program (CMP) is designed to show you what simple circuits look like in the frequency and time domains. You may enter a nodal description (up to 200 nodes) of a circuit containing resistors, capacitors, inductors, and lossy transmission lines. The circuit is then analyzed by the Circuit Modeling Program and the S-parameters are loaded into the HP 8510 trace memories via the HP-IB interface bus.

Using the HP 8510 front panel controls, the computed data can then be viewed in the frequency domain or the time domain. Circuit descriptions may also be stored on an HP series 200 computer disc device library and loaded again later.

## HARDWARE REQUIREMENTS

The Circuit Modeling Program runs on HP series 200 computers: HP model numbers 9816, 9826, 9836, 9836C, and 9920. It requires that your HP 8510 network analyzer system have the time domain Option 010 installed.

The Circuit Modeling Program is compiled in Pascal 2.0. The HP 8510 is not required for program operation; computed frequency domain (only) data may be printed or plotted under control of the HP series 200 computer.

## LOAD AND EXECUTE CMP

Load the Circuit Modeling Program as follows:

1. Connect the HP series 200 computer to the HP 8510 rear panel using an HP-IB cable. Turn on the test set, source, printer, plotter, and other instruments which may be connected to the HP 8510 system bus. Then turn on the power to the HP 8510.
2. Turn on any external mass storage devices and wait a few seconds for any possible self-test to complete.
3. Remove the write protect tab from the disc labeled BOOT: (HP Part Number 85101-10004) and place the disc in the right-hand internal disc drive of the HP series 200 computer or in drive 0 of the external disc drive.
4. Turn on the computer. It will take about 1 minute for the BOOT: disc to load.
5. When the message "Put in the PROG: disc and press ENTER" appears, remove the BOOT: disc and insert the PROG: disc (HP Part Number 85101-10005). Press the ENTER key. The CMP program should display a title message and then a > prompt. Leave the PROG: disc in the drive. The program is now loaded and ready to use.

To copy the program use the HP series 200 BASIC or PASCAL operating system.

## COMMANDS

Commands are instructions to the CMP for some immediate action to take place. Commands are entered by typing them on the keyboard. When ENTER is pressed, the requested action is begun. When the action is completed a > prompt is displayed.

## STATEMENTS

Statements are different from commands in that they are stored for future execution rather than immediate action. All statements must begin with a line number from 1 to 9999. Statement numbers are used to determine the order of execution of the various statements.

## EDITING COMMANDS AND STATEMENTS

The HP series 200 computer editing keys (INS LN, DEL LN, INS CHR, DEL CHR, RECALL, CLR>END) on the computer keyboard are not used with this program. The BACKSPACE key is used to correct typing errors as they are entered.

To enter a line, type a line number followed by the keyword and parameters, and then press ENTER.

To replace a line, type the same line number as the number of the line you want to replace, then type the keyword.

To insert a line in a program, type the line with a unique line number that is between the two line numbers between which you wish to insert the line.

To delete a line, type the line number with no text following it. To delete the entire program, type the DEL command.

## HELP

For a list of commands and statements, type the command HELP, then press ENTER.

To get more information about any command or statement, type the command HELP <keyword>, using as the <keyword> any command or statement.

**RCL EXAMPLE**

The following circuit is stored as an example on the PROG: disc, and it can be analyzed and the data sent to the HP 8510 using the program below. Figure 1 shows a schematic diagram of this circuit.

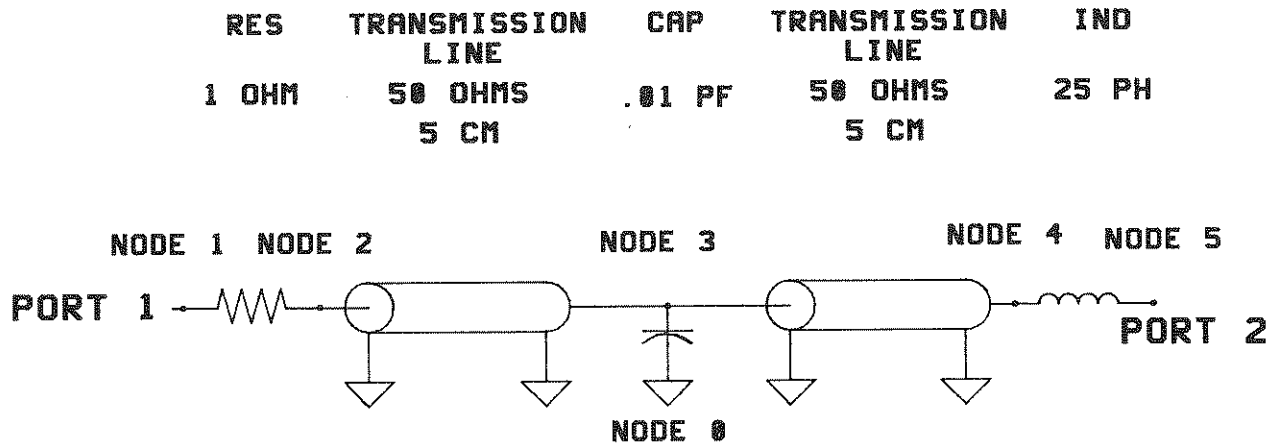

*Figure 1. RCL Example Schematic Diagram*

Load this example by typing the following command:

GET RCL

Next type:

LIST

You should see the following:

```

10 PORT 1 0
20 R 1 2 1 OHMS
30 TL 2 3 50 OHMS 5 CM
40 C 3 0 .01 PF
50 TL 3 4 50 OHMS 5 CM
60 L 4 5 25 PH
70 PORT 5 0
80 FREQ 90 MHZ 18090 MHZ 201 POINTS
90 PLOT S11, S12, S21, S22
100 OUTPUT S11
    
```

Next type:     RUN

For approximately the next 20 seconds the computer will generate data, output the data to the HP series 200 controller display (PLOT statements), then output data to the HP 8510 (OUTPUT statement). Data sent the HP 8510 via the HP-IB includes commands to set the network analyzer to display the selected parameter in the frequency domain, and data representing the response of the modeled circuit. When data transfer is completed, the HP 8510 CRT is updated with new trace data and set to HOLD.

The S-parameters of this circuit are displayed on the HP series 200 computer and  $S_{11}$  is displayed on the HP 8510 CRT. The trace on the HP 8510 CRT display should resemble the plot shown in Figure 2. You may have to press **AUTO** on the HP 8510 in order to bring the response fully onto the screen.

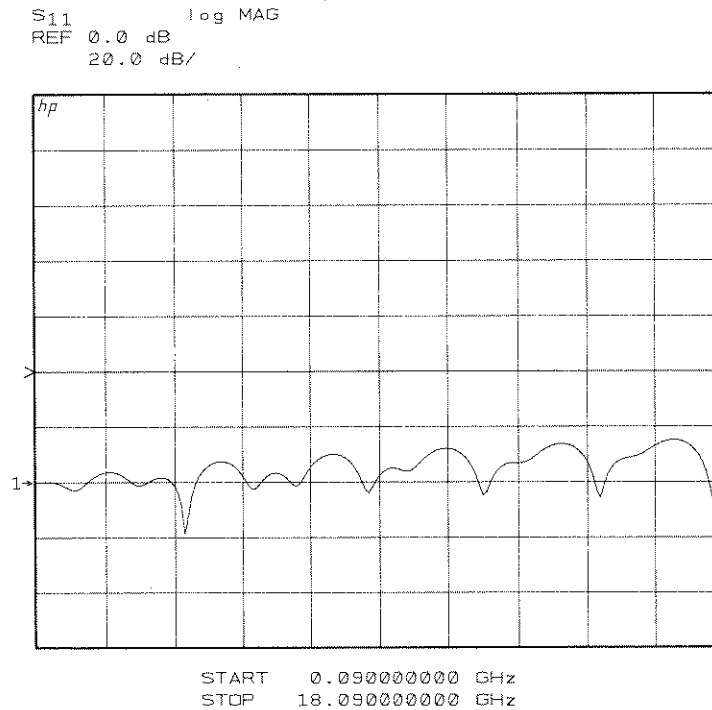

Figure 2. RCL Example  $S_{11}$  Frequency Domain Response

Any of the four S-parameters ( $S_{11}$ ,  $S_{12}$ ,  $S_{21}$ ,  $S_{22}$ ) can be displayed on the HP 8510 using the OUTPUT command. Issue a command by typing the statement, then pressing ENTER. Issue this command to display  $S_{21}$  on the HP 8510 CRT display:

OUTPUT S21

The trace should resemble the plot shown in Figure 3.

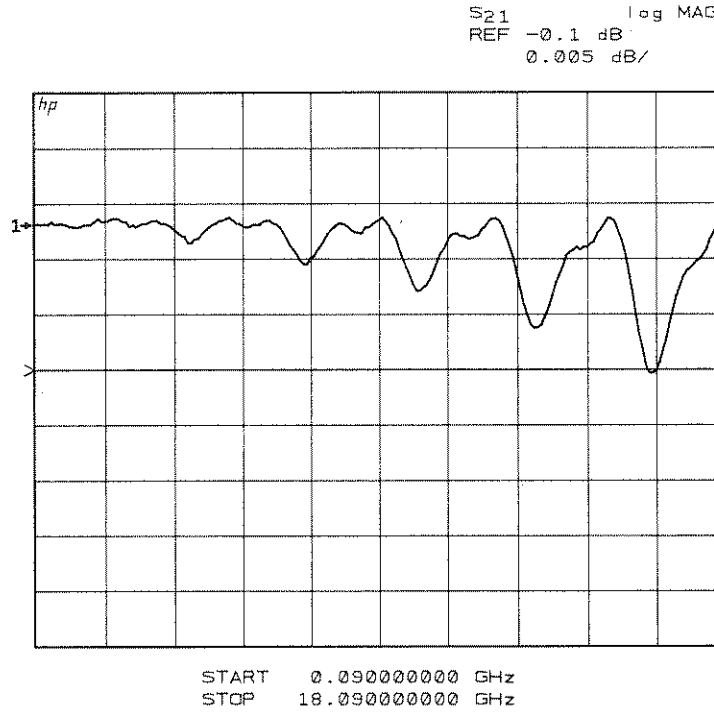

Figure 3. RCL Example  $S_{21}$  Frequency Domain Response



The time domain response of the circuit model can be displayed on the HP 8510 CRT in the following way. First issue the following command:

### OUTPUT S11

The HP 8510 CRT should now display the frequency domain  $S_{11}$  response of the circuit.

To display the time domain response, press the following on the HP 8510:

- Press **DOMAIN**  
**TIME LOW PASS**  
**SET FREQ. (LOW PASS)**
- Press **START**  
Enter **-0.5 G/n**  
Press **STOP**  
Enter **1.5 G/n**
- Press **AUTO**

The trace on the HP 8510 CRT should resemble the plot shown in Figure 4.

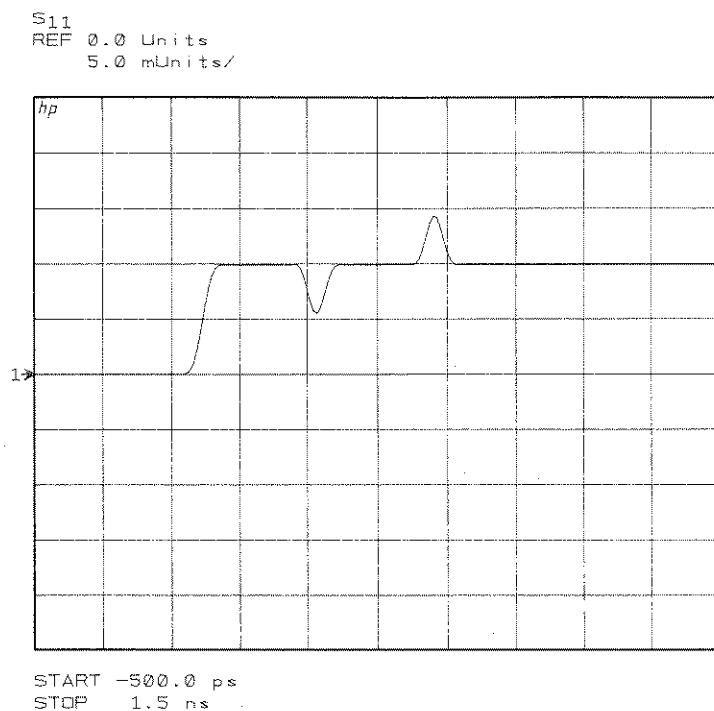

Figure 4. RCL Example  $S_{11}$  Time Domain Response

**LOSSY TRANSMISSION LINE EXAMPLE**

A transmission line can have two different types of loss: series and shunt. Series loss is a resistance that is distributed in series with the length of the transmission line, and it is usually expressed as resistance per unit length.

Shunt loss is a resistance shown between the center and outer conductors. It is distributed along the length of the transmission line, and it is usually expressed as conductance per unit length.

Figure 5 shows a schematic diagram of this simple lossy transmission line.

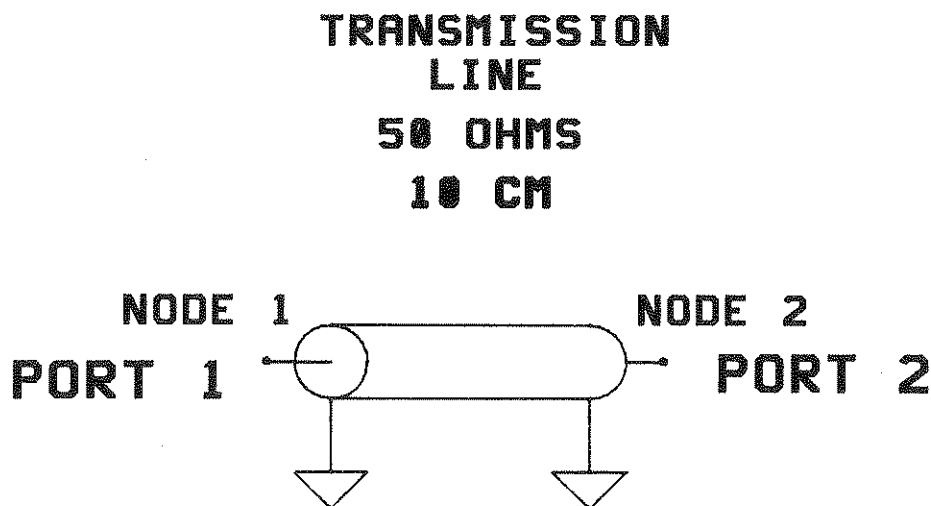

*Figure 5. Lossy Transmission Line Schematic Diagram*

To analyze this example, first type DELETE to delete the previous circuit model from memory. Then type the following command:

```
GET TL SERIES
```

Now type LIST to view the circuit description:

```
10 PORT 1 0
20 TL 1 2 50 OHMS 10 CM 1 .1
30 PORT 2 0
40 FREQ 90 MHZ 18090 MHZ 201 POINTS
50 PLOT S11
60 OUTPUTS11
```

This transmission line has 50 ohms impedance, 10 cm length, velocity factor of 1, and a series loss of 0.1 ohm/cm (unit of length was set by the length parameter).

Now type: RUN

$S_{11}$  of the transmission line is displayed on the screen of the HP 8510. The trace on the HP 8510 CRT should resemble the plot shown in Figure 6.

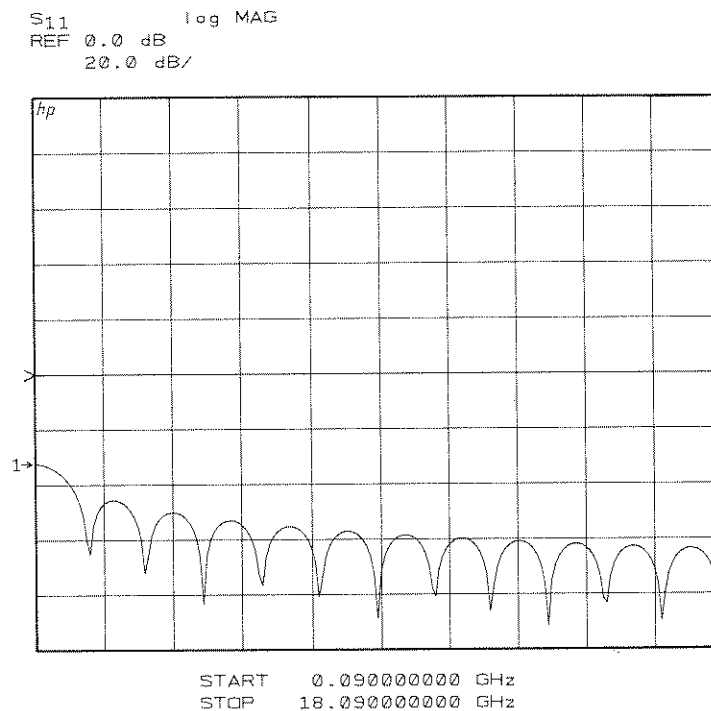

Figure 6. Lossy Transmission Line  $S_{11}$  Frequency Domain Response

The time domain response of the circuit can be displayed on the HP 8510 CRT using the same control sequence as described in the RCL example:

- Type OUTPUT S11

The HP 8510 CRT should now display the frequency domain  $S_{11}$  response of the circuit.

To display the time domain response, press the following on the HP 8510:

- Press DOMAIN  
TIME LOW PASS  
SET FREQ. (LOW PASS)
- Press START  
Enter -0.5 G/n  
Press STOP  
Enter 1.5 G/n
- Press AUTO

The trace which now appears on the HP 8510 CRT should resemble the plot shown in Figure 7.

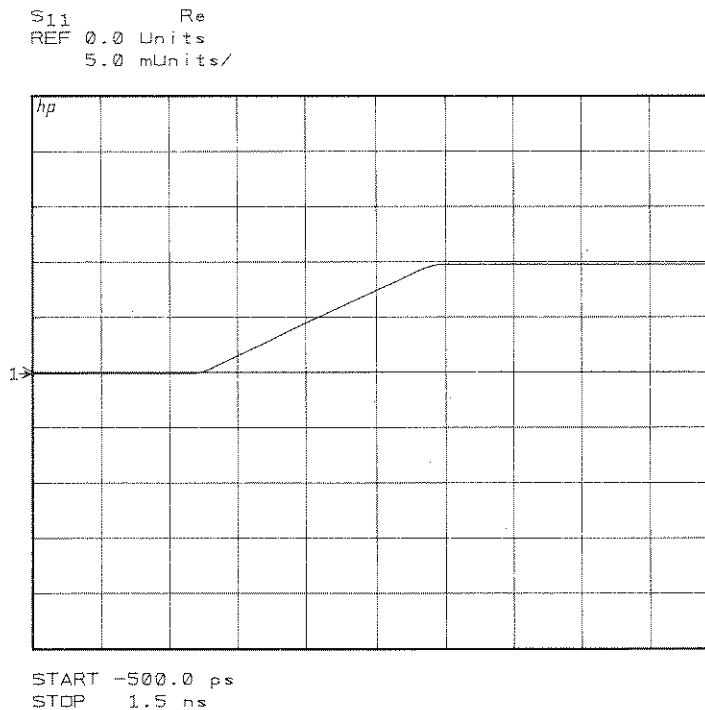

Figure 7. Lossy Transmission Line  $S_{11}$  Time Domain Response

Now, to see an example of a transmission line with shunt loss, change the program by typing:

```
20 TL 1 2 50 OHMS 10 CM 1 0 0 .0001
```

This will give a shunt conductance of 0.0001 mhos per cm (10000 ohm-cm). Since the transmission line is 10 cm long, it will have 1000 ohms in shunt with it. Enter RUN. The frequency response trace on the HP 8510 CRT should resemble the plot shown in Figure 8.

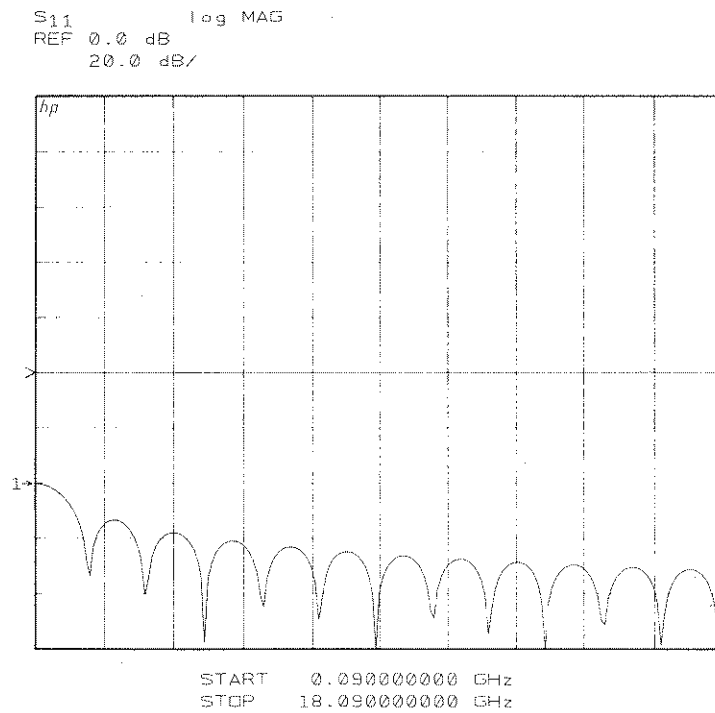
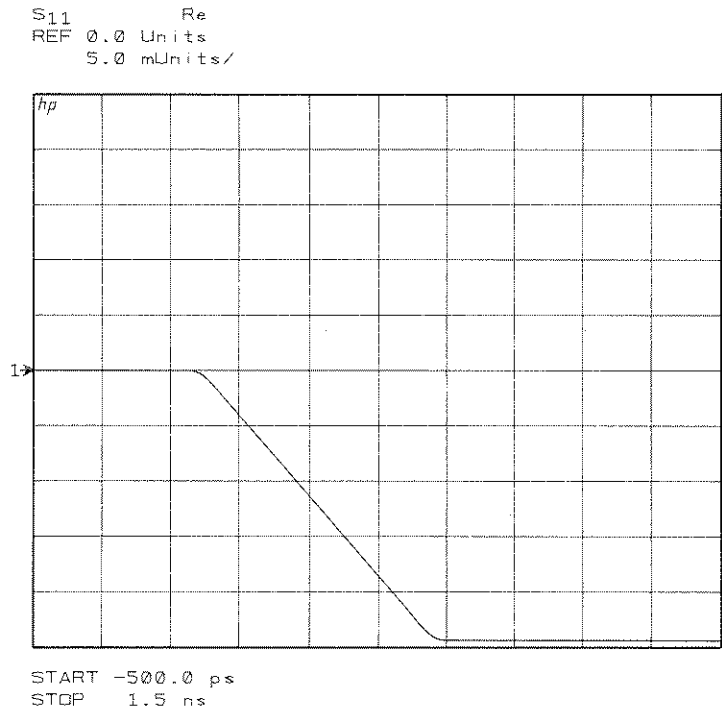

Figure 8. Lossy Transmission Line Example  $S_{11}$  Frequency Domain Response with Shunt Loss Added

The appearance of the series and shunt loss is hard to distinguish in the frequency domain. But in time domain it is easy to see the difference.

To display shunt loss in the time domain, convert to the TIME LOW PASS mode using the same time domain sequence with the HP 8510 used before. The trace on the HP 8510 CRT should resemble the plot shown in Figure 9.

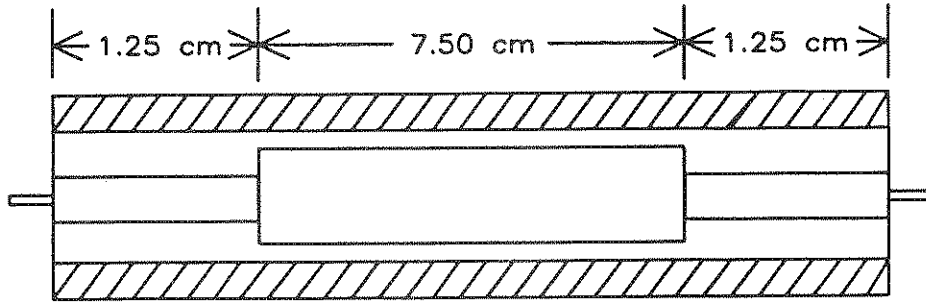

*Figure 9. Lossy Transmission Line Example S<sub>11</sub> Time Domain Response with Shunt Loss Added*

**TWO-PORT STEPPED IMPEDANCE STANDARD EXAMPLE**

This example shows the use of time domain to observe the effects of mismatched transmission lines. The following example is based on the two-port stepped impedance standard in the HP 85051A 7mm verification kit. Details on this device appear in Figure 10.

*Physical Example*



*Circuit Schematic Model*

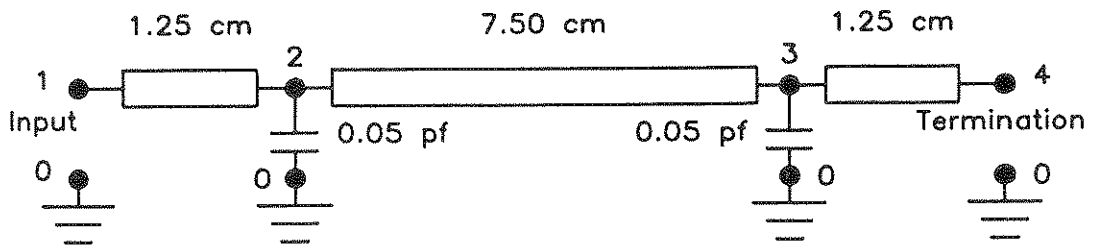

*Figure 10. Two-Port Stepped Impedance Standard*

To load this example, first type DELETE to delete the previous circuit model from memory. Then type the following command:

```
GET IMPSTD
```

```
LIST
```

Now enter the following statements:

```
10 PORT      1 0
20 TL        1 2    50 OHMS  1.25 CM
30 C         2 0    50 fF
40 TL        2 3    25 OHMS  7.50 CM
50 C         3 0    50 fF
60 TL        3 4    50 OHMS  1.25 CM
70 PORT      4 0
80 FREQ      45 MHZ 18045 MHZ 401 POINTS
90 PLOT      S11
100 OUTPUTS11
```

To analyze the circuit, now type:

```
RUN
```

The program takes about 45 seconds to run. The trace on the HP 8510 CRT should resemble the  $S_{11}$  frequency domain plot shown in Figure 11.

If converted to the TIME DOMAIN LOW PASS mode, the trace on the HP 8510 CRT should resemble the  $S_{11}$  time domain plot shown in Figure 12.



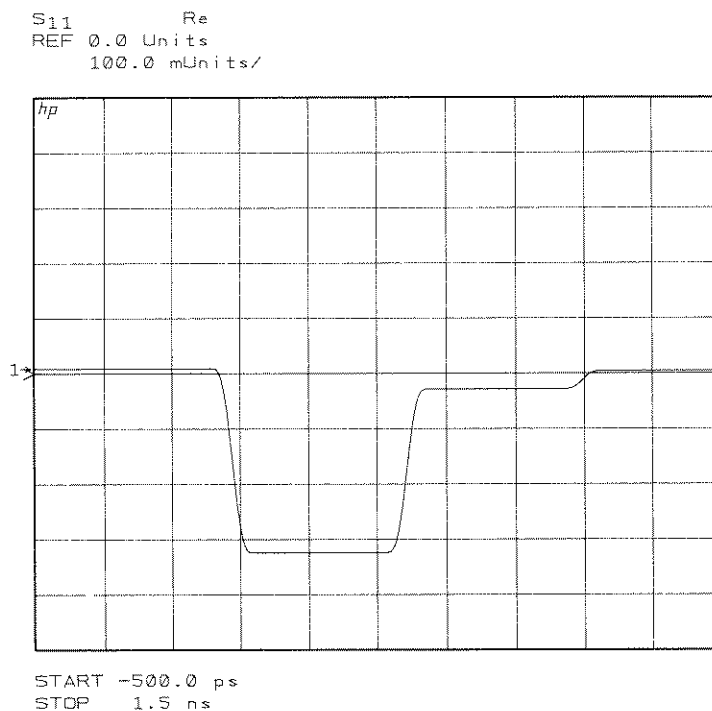

Figure 11. Two-Port Stepped Impedance Standard  $S_{11}$  Frequency Domain Response

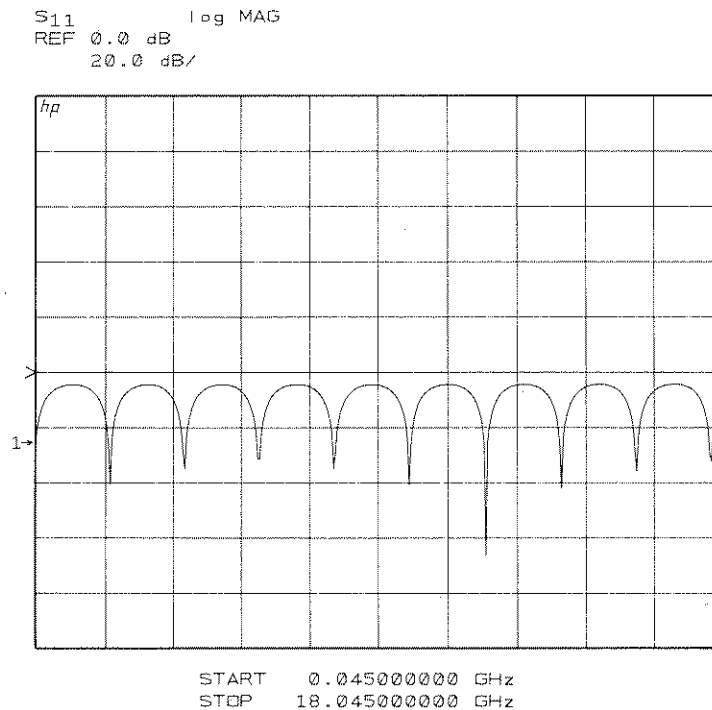

Figure 12. Two-Port Stepped Impedance Standard  $S_{11}$  Time Domain Response



## COMMAND AND STATEMENT REFERENCE

## CMP PROGRAM STATEMENTS

nnn PORT	Node	(50 ohm termination)
nnn R	Node1 Node2	Resistance
nnn L	Node1 Node2	Inductance
nnn C	Node1 Node2	Capacitance
nnn TL	Node1 Node2	Z Len Velocity Series Reffreq Shunt
nnn	FREQ parameters	
nnn	OUTPUT parameter	(Send S parameter data to HP 8510)
nnn	PLOT parameters	(Plot S parameter data on CRT)

NOTES: nnn represents a line number.  
OUTPUT and PLOT can also be used as commands after the program has been RUN once.  
The key [CLR I/O] interrupts an executing command and returns the program to user control.

## CMP COMMANDS

CAT	END
DEL	BYE
GET	EXIT
HELP	QUIT
LIST	
RUN	
SAVE	
PURGE	
OUTPUT	
PLOT	

## CMP STATEMENT SYNTAX

## PORT

This circuit element mimics a network analyzer port. It appears from the circuit to be a simple 50 ohm resistor but it is capable of both supplying and measuring power.

```
nmn PORT Node
```

Example:           10 PORT 1

## RESISTOR

```
nmn R Node1 Node2 Resistance in ohms
```

Example:           10 R 1 0           50 Ohms

(The keyword Ohms is optional.)

## INDUCTOR

```
nmn L Node1 Node2 Inductance
```

The following inductance suffixes are allowed:

H mH uH nH pH fH

Example:           10 L 1 0           10 nH

## CAPACITOR

```
nmn C Node1 Node2 Capacitance
```

The following capacitance suffixes are allowed:

F mF uF nF pF fF

Example:           10 C 1 0           100pF

## TRANSMISSION LINE

```

nnn TL Node1 Node2 Z0 Length Velocity Series CorFreq Shunt

```

Node1	Center conductor of port 1.
Node2	Center conductor of port 2.
Z	Characteristic impedance of lossless line.
Length	Length of line. The default units are meters but the following units are also accepted: cm, mm, in.
Velocity	Propagation velocity relative to the speed of light in a vacuum. Default value is 1.0.
Series	DC series resistance per unit length. Default value is 0.0.
CorFreq	Corner frequency for skin effect. This is the frequency at which the depth of penetration equals the metal thickness. This occurs when the series resistance is 1.086 times larger than the DC value. A parallel line structure is assumed. Default value is 0.0, which removes skin effect.
Shunt	Shunt conductance per unit length. Default value is 0.0.

```

Examples: 10 TL 1 2 50 10 mm
          10 TL 1 2 50 10 mm 1.0 0.01 1 GHZ 0.0

```

## FREQUENCY

Used to set the start frequency, stop frequency, and number of points used for the circuit simulation. Frequencies used must be within the limits of the HP 8510 and its source.

Format:                    nnn FREQ Fstart Fstop NumOfSteps  
                             or  
                             nnn FREQ LOWPASS Fstop NumOfSteps

Fstart                    Start frequency.

Fstop                    Stop frequency.

The following frequency suffixes are allowed:

Hz kHz MHz GHz.

NumOfSteps            Number of frequency points to calculate. Default is 51. NumOfSteps must be 51, 101, 201 or 401 to send data to the HP 8510.

LOWPASS              Keyword causes the Fstart to be calculated by the HP 8510. This is used by the low pass time domain mode of the HP 8510.

Examples:              100 FREQ 1 GHz 10 GHz  
                             100 FREQ LOWPASS 10 GHz 201

## OUTPUT

This command transfers data to the HP 8510. To use this command an HP 8510 must be present on the HP-IB at address 16.

Format:                    nnn OUTPUT Snn

Where Snn is one of the following: S11, S12, S21 or S22.

When the OUTPUT command is executed, the HP 8510 state will be modified as follows:

- Domain set to frequency,
- Frequency range and number of points set,
- Error correction turned off,
- Averaging turned off,
- Smoothing turned off,
- Sweep time set to 301 ms,
- Placed in HOLD mode,
- Placed in LOCAL mode.

Example:                    100 OUTPUT S11

## PLOT

Format:                    nnn PLOT parameters

Available parameters are S11, S12, S21, and S22. S11 and S22 will always be plotted on a Smith chart. S12 and S21 will always be plotted in log-magnitude format. One PLOT statement can plot all four S-parameters.

Separating parameters by a space causes them to be plotted on the same grid. Separating parameters by a comma causes them to be plotted on separate grids. It is not possible to plot S11 or S22 on the same grid as S12 or S21.

## Examples:

100	PLOT S11	(Plots S11 on a Smith chart.)
100	PLOT S11 S22	(Plots both on a Smith chart.)
100	PLOT S11,S12,S21,S22	(Plots each on a separate grid.)
100	PLOT S11 S22,S12 S21	(Plots S11 and S22 together on the same Smith chart, and S12 and S21 together on a separate Cartesian grid.)



## COMMANDS

### CATALOG

This command lists the files available on prefix volume.

Format:               CAT <optional volume specifier - Pascal syntax>

Examples:             CAT  
                      CAT #4:

### DELETE

This command deletes the current circuit.

Format:               DEL

### GET

This command loads a circuit description from a file.

Format:               GET FileName

### LIST

This command lists the circuit description.

Format:               LIST

### PURGE

This command purges a file from the disc.

Format:               PURGE FileName

RUN

This command performs a circuit analysis.

Format:                    RUN

SAVE

This command saves a circuit description to a file.

Format:                    SAVE FileName

EXIT

This command exits the CMP program.

Format:                    BYE  
                             EXIT  
                             QUIT

## REPLACEMENT PARTS

<u>HP PART NUMBER</u>	<u>DESCRIPTION</u>
85101-60040	COMPLETE SET OF DISCS (3.5 AND 5.25 INCH)
85101-10004	BOOT DISCS (3.5 AND 5.25 INCH)
85101-10005	PROG DISCS (3.5 AND 5.25 INCH)



---

**REFERENCE DATA**

---

<b>INTRODUCTION</b>	5
<b>FRONT PANEL CONTROLS AND MNEMONICS</b>	7
<b>OVERALL MENU STRUCTURE</b>	9
<b>STIMULUS MENU STRUCTURE</b>	15
Stimulus Menu	15
Source Power Menu	15
Number of Points Menu	15
<b>PARAMETER MENU STRUCTURE</b>	17
Parameter Menu	17
Redefine Parameter Menu	17
Drive Menu	17
Phase Lock Menu	17
Numerator Menu	17
Denominator Menu	17
Conversion Menu	17
<b>FORMAT MENU</b>	19
<b>RESPONSE MENU</b>	21

<b>CAL MENU STRUCTURE</b>	23
Cal Menu	23
Cal Type Menu	23
Port Extensions Menu	23
Cal Set Selection Menu	25
Registers and Calibration Coefficient Storage	26
Recalling Cal Sets	26
Calibration Error Coefficient Storage	27
Frequency Response Menu	28
<b>1-PORT CAL MENU STRUCTURE</b>	29
$S_{11}$ Cal Menu	29
$S_{22}$ Cal Menu	29
Loads Menu	29
Sliding Load Menu	29
<b>ONE-PATH 2-PORT CAL MENU STRUCTURE</b>	31
One-Path 2-Port Cal Menu	31
$S_{11}$ Cal Menu	31
Loads Menu	31
Sliding Load Menu	31
One-Path Transmission Cal Menu	31
One-Path Isolation Cal Menu	31
<b>FULL 2-PORT CAL MENU STRUCTURE</b>	33
Full 2-Port Cal Menu	33
Full 2-Port Reflection Cal Menu	33
Loads Menu	33
Sliding Load Menu	33
Full 2-Port Transmission Cal Menu	33
Full 2-Port Isolation Cal Menu	33

<b>MODIFY CAL KIT MENU STRUCTURE</b>	35
Modify Cal Kit Menu	35
Standard Type Menu	35
Standard Definition Menu	35
Specify Offset Menu	35
Specify Class Menu	35
Label Class Menu	35
<b>DOMAIN MENU STRUCTURE</b>	37
Domain Menu	37
Set Frequency (Low Pass) Menu	37
Specify Time Menu	37
Specify Gate Menu	37
Gate Shape Menu	37
<b>DISPLAY MENU STRUCTURE</b>	39
Display Menu	39
Select Defaults Menu	39
Math Operations Menu	39
Dual Channel Menu	39
<b>MARKER MENU STRUCTURE</b>	41
Marker Menu	41
$\Delta$ Mode Menu	41
<b>COPY MENU STRUCTURE</b>	43
Copy Menu	43
Plot Quadrant Menu	43
Pen Select Menu	43
System Parameters Menu	43
Operating Parameters Menu	43
<b>TAPE MENU STRUCTURE</b>	45
Tape Menu	45

Directory Menu	45
Data Type Menu	45
Instrument State Selection Menu	45
Trace Memory Selection Menu	45
Cal Set Selection Menu	45
Cal Kit Selection Menu	45
File Selection Menu	45
Initialize Tape Menu	45
File Types and Size	47
Storing Instrument States: Sample Sequence	48
<b>SYSTEM MENU STRUCTURE</b>	<b>49</b>
System Menu	49
Address Menu	49
Service Functions Menu	49
LF. Gain Menu	49
Gain Selection Menu	49
Test Menu	49
<b>SAVE/RECALL MENU</b>	<b>51</b>
<b>LOCAL MENU</b>	<b>53</b>
<b>TITLE MENU</b>	<b>55</b>
<b>SERVICE SELECTIONS MENU</b>	<b>57</b>
<b>HP-IB ONLY PROGRAMMING CODES</b>	<b>59</b>
<b>ERROR MESSAGES</b>	<b>61</b>
<b>USER DISPLAY GRAPHICS</b>	<b>67</b>
<b>CIRCUIT MODELING PROGRAM MNEMONICS</b>	<b>71</b>



## INTRODUCTION

This part of the HP 8510 network analyzer system manual provides detailed, application-independent descriptions of the controls, indicators, connections, operating characteristics, and HP-IB programming codes of the HP 8510 system. It is designed for quick reference rather than to duplicate the detailed operating information provide elsewhere.

**FRONT PANEL CONTROLS AND MNEMONICS** gives the names and, when applicable, also the HP-IB programming mnemonics of all HP 8510 network analyzer system front panel controls.

**OVERALL MENU STRUCTURE** presents in outline form the overall structure and relationship of the first-level, second-level, and other menus displayed on the HP 8510 system CRT display.

**MENUS** follow this overall outline, showing each menu structure and menu pictorially and, when applicable, also giving the HP-IB programming mnemonics for each menu choice. Notes on using the individual menus are also supplied when needed. Menus identified only by name on a menu structure diagram will be found on pages immediately after the structure diagram, except for the Title Menu and the Service Selections Menu. These two menus are given separately after all of the other menus.

**HP-IB ONLY PROGRAMMING CODES** lists and briefly explains the function of each of the HP-IB programming codes used with the HP 8510 network analyzer system.

**ERROR MESSAGES** lists each of the error messages displayed by the HP 8510 system by error number.

**USER DISPLAY GRAPHICS** explains the programming statements used to plot vectors and text onto the User Display area of the HP 8510 network analyzer system CRT.

**CIRCUIT MODELING PROGRAM MNEMONICS** explains programming syntax and commands used in the Circuit Modeling Program.



## FRONT PANEL CONTROLS AND MNEMONICS

Listed here are the names and, when applicable, also the HP-IB programming mnemonics of all HP 8510 network analyzer system front panel controls.

FRONT PANEL CONTROL	<i>Mnemonic</i>
LINE	
CRT	
INTENSITY	
FOCUS	
ALIGN	
TEST	
PRIOR MENU	MENUPRIO
ENTRY	
knob	
STEP ↑	DOWN
STEP ↓	UP
ENTRY OFF	ENTO
Numeric Pad	0 1 2 3 4 5 7 8 9 . + -
Units Pad	
G/n (Giga/nano)	GHZ, NS, PS, FS
M/μ (mega/micro)	MHZ, US
k/m (kilo/milli)	KHZ, MS
x1 (basic units)	HZ, S
BACKSPACE	
= MARKER	EQUA
CHANNEL 1	CHAN1
CHANNEL 2	CHAN2

NOTE: The Units Pad mnemonics PS and FS (picoseconds, femtoseconds) have no front-panel key equivalents but can be used in programming.

<p><u>STIMULUS</u></p> <p>START                    STAR            STOP                    STOP            CENTER                CENT            SPAN                    SPAN            MENU                    MENUSTIM</p>	<p><u>MENUS</u></p> <p>CAL                    MENCAL            DOMAIN                MENUDOMA            DISPLAY                MENUDISP            MARKER                MENUMARK</p>
<p><u>PARAMETER</u></p> <p>S<sub>11</sub>                    S11            S<sub>21</sub>                    S21            S<sub>12</sub>                    S12            S<sub>22</sub>                    S22            MENU                    MENUPARA</p>	<p><u>INSTRUMENT STATE</u></p> <p>LOCAL            SAVE                    MENUSAVE            RECALL                MENURECA            PRESET                PRES</p>
<p><u>FORMAT</u></p> <p>LOG MAG                LOGM            DELAY                    DELA            PHASE                    PHAS            SMITH CHART            SMIC            MENU                    MENUFORM</p>	<p><u>AUXILIARY MENUS</u></p> <p>COPY                    MENCOPY            TAPE                    MENUTAPE            SYSTEM                MENUSYST</p>
<p><u>RESPONSE</u></p> <p>SCALE                    SCAL            REF VALUE                REFV            AUTO                    AUTO            REF POSN                REFP            MENU                    MENURESP</p>	<p><u>MEASUREMENT</u></p> <p><u>RESTART</u></p> <p>REST</p>

## OVERALL MENU STRUCTURE

Thirteen first-level (or main) menus exist in the HP 8510 network analyzer system, and each is shown here with the second-level and other menus to which it gives access.

First-level menus are brought onto the CRT display by pressing the front-panel keys labeled **MENU** in the four HP 8510 function blocks, **STIMULUS**, **PARAMETER**, **FORMAT**, and **DISPLAY**, or by pressing front-panel keys, labeled with the menu name, in other blocks. Second-level and other menus are brought onto the display by pressing softkeys beside the CRT display after the first-level menu or another previous menu has appeared. Press the front-panel key labeled **PRIOR MENU** to return to the menu previously displayed.

On the menu display, the value or choice currently being used in system operation is underlined. Mutually exclusive choices are connected by dots. Pressing the softkey beside a label displayed on the CRT either executes the function or presents another menu. If the choice selected requires an input, a prompt will appear on the CRT display when the softkey is pressed. Use the knob, step, and numeric keys in the **ENTRY** block to change the current value of the active function.

The overall menu structure of the HP 8510 system is shown first, in outline. Then each individual menu structure or first-level menu is shown pictorially. HP-IB programming mnemonics are given with the individual menus when a programming mnemonic exists for that function or choice.

Menus identified only by name on a menu structure diagram will be found on pages immediately after the structure diagram, except for the Title Menu and the Service Selections Menu. These two menus are given separately after all of the other menus. Consult the Table of Contents in this section if you have trouble finding a particular menu.

OVERALL MENU STRUCTURE

STIMULUS

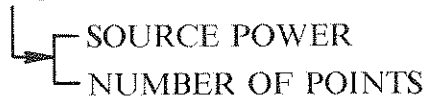

PARAMETER

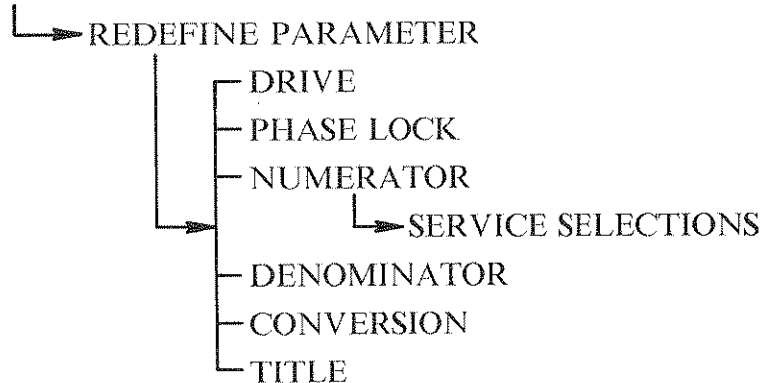

FORMAT

RESPONSE

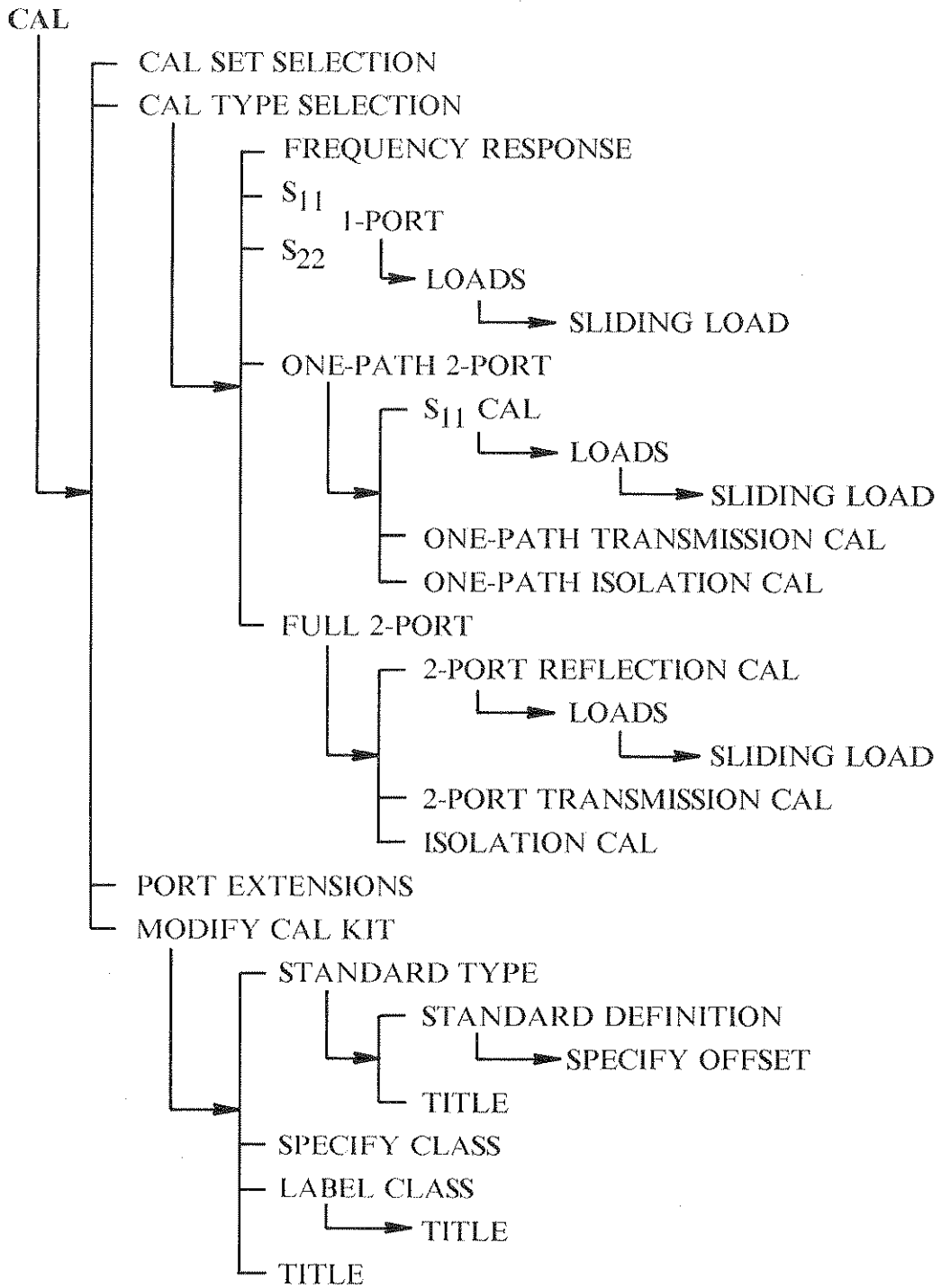

DOMAIN

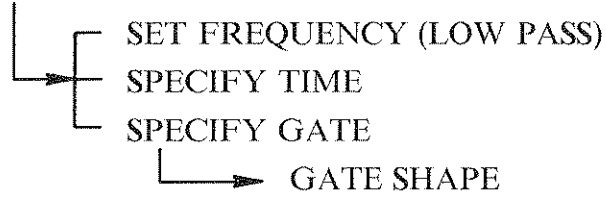

DISPLAY

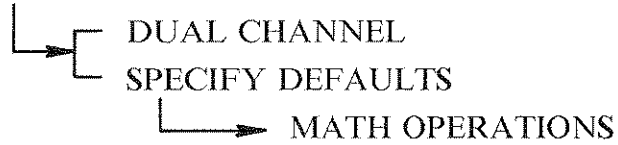

MARKER



COPY

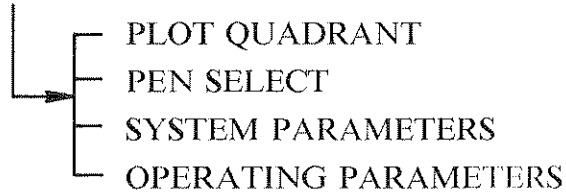

TAPE





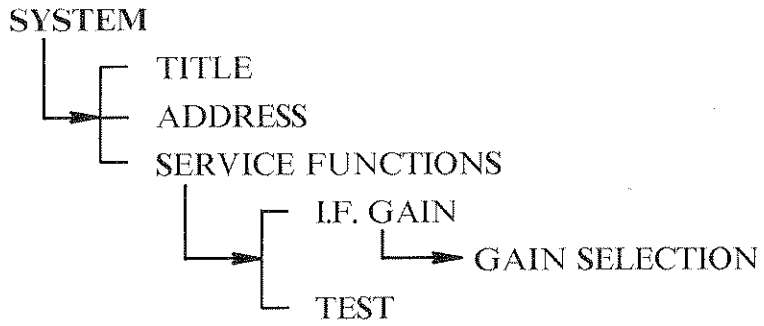

SAVE/RECALL

LOCAL



STIMULUS MENU STRUCTURE

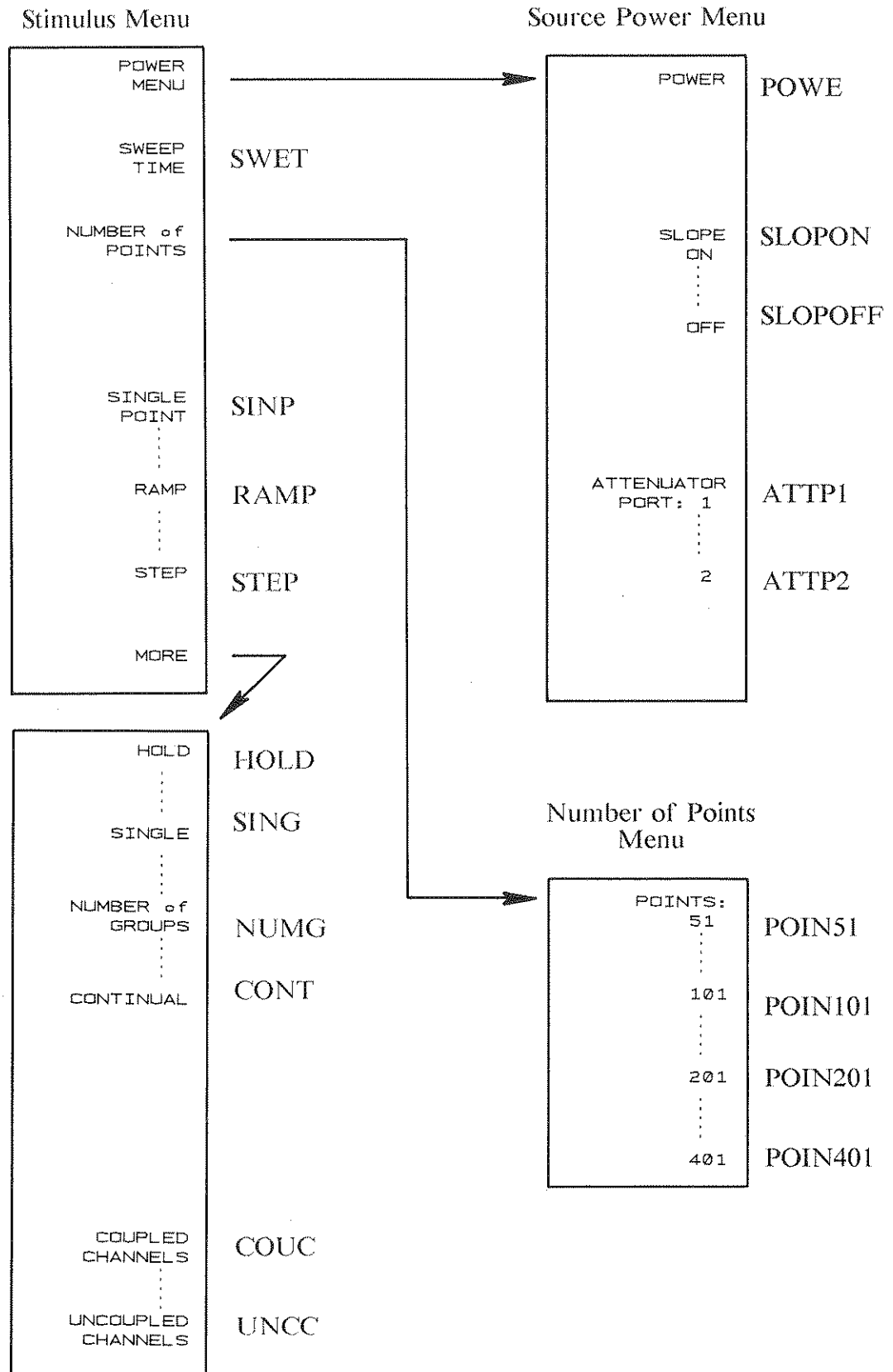



Parameter Menu

```

USER 1
  a1
  .
  .
USER 2
  b2
  .
  .
USER 3
  a2
  .
  .
USER 4
  b1
  .
  .
REDEFINE
PARAMETER
  
```

USER1  
USER2  
USER3  
USER4

Drive Menu

```

DRIVE:
PORT 1
  .
  .
PORT 2
  .
  .
NONE
  
```

DRIVPORT1  
DRIVPORT2  
DRIVNONE

Phase Lock Menu

```

LOCK to
  a1
  .
  .
  a2
  .
  .
NONE
  
```

LOCKA1  
LOCKA2  
LOCKNONE

Redefine Parameter Menu

```

DRIVE
  .
  .
PHASE
LOCK
  .
  .
NUMERATOR
  .
  .
DENOMI-
NATOR
  .
  .
CONVERSION
  .
  .
PARAMETER
LABEL
  .
  .
REDEFINE
DONE
  
```

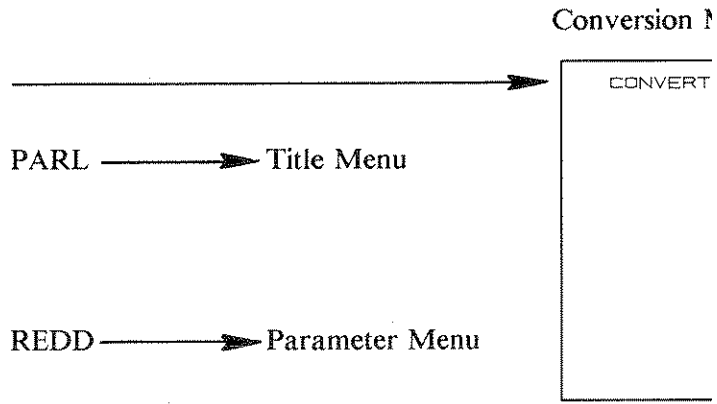

R M

➤ R

➤ F

Menu

to  
S  
1/S  
Z  
Y

FORMAT MENU

Format Menu

SWR	SWR
.....	
LINEAR MAGNITUDE	LINM
.....	
LIN mkr on POLAR	LINP
.....	
LOG mkr on POLAR	LOGP
.....	
Re/Im mkr on POLAR	REIP
.....	
INVERTED SMITH	INVS
.....	
IMAGINARY	IMAG
.....	
REAL	REAL

RESPONSE MENU

Response Menu

ELECTRICAL DELAY	ELED
PHASE OFFSET	PHAO
AVERAGING ON/restart ..... OFF	AVERON  AVEROFF
SMOOTHING ON ..... OFF	SMOON  SMOOFF

Cal Set Selection Menu

*Next Menu*

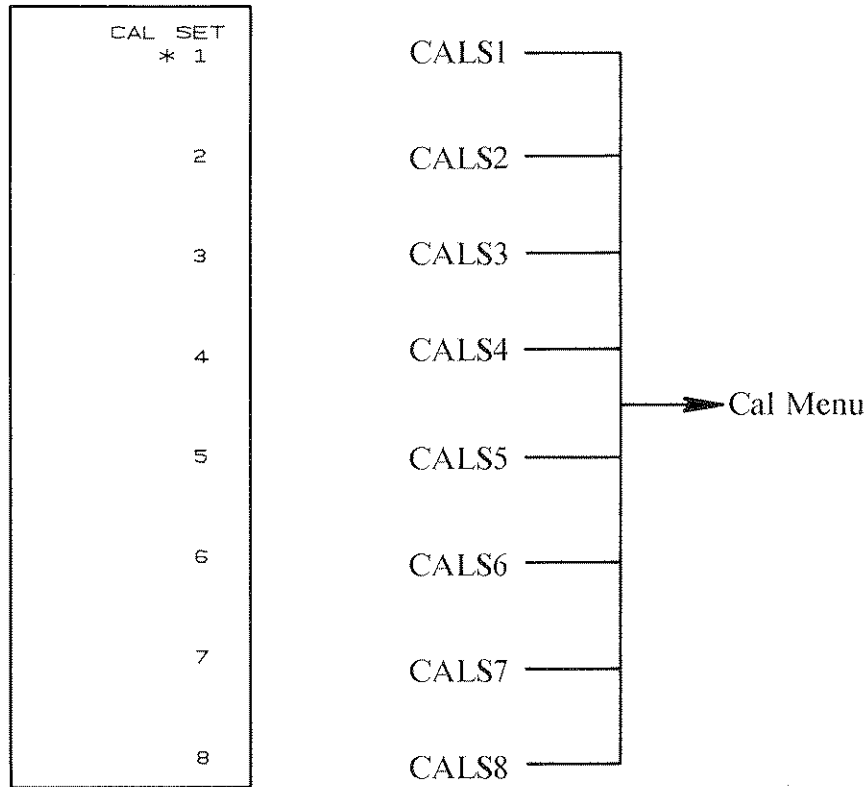

**SELECTING CAL SETS**

In addition to the Cal Set Selection Menu, the prompt **SELECT CALIBRATION SET** will appear, and there will be an asterisk (\*) beside all cal set numbers in which calibration coefficients have already been stored.

**STORING CAL SETS**

After measurement calibration, selecting a cal set using the Cal Set Select Menu stores the error coefficients and the Cal Set Limited Instrument State given on the next page in the Cal Set. If the selected cal set applies to the presently selected parameter, the stimulus values are set to the defined values and the CAL menu is displayed with **CORRECTION ON**. Selecting a cal set already used deletes the existing cal coefficients and stores the new cal coefficients in the Cal Set. An asterisk (\*) will appear beside the cal set number.



**REGISTERS AND CALIBRATION COEFFICIENT STORAGE**

The system keeps track of assignments and available storage. Maximum storage for calibration coefficients depends on the type of calibration and the number of points. Maximum storage available for calibrations of each single type is as follows; storage for calibrations of several types can be approximated from the table knowing the relative space requirements.

Cal Type	Number of Points			
	51	101	201	401
Frequency Response	8	8	8	8
1-Port	8	8	8	8
2-Port	8	8	4	2

The Cal Set also includes critical calibration information relating to the stimulus settings.

**RECALLING CAL SETS**

The Cal Set Limited Instrument State listed below contains important network analyzer control settings at the time the cal set was stored. Recalling a cal set restores all of the stimulus settings (listed below) to their state at the time the cal set was saved.

*Cal Set Limited Instrument State*

Parameter(s) Corrected will not turn Correction On if parameter is not included
Frequency Range Number of Points both turn Correction Off if changed and new parameter is not included
Source Power Sweep Time Power Slope Ramp/Step/Single Point Trim Sweep Sweep Mode

### CALIBRATION ERROR COEFFICIENT STORAGE

To load error coefficients into the HP 8510 network analyzer memory from an external controller, first load all appropriate calibration coefficient arrays. Then issue the HP-IB SAVC;CALSn instruction. This will save the coefficients in their proper location.

INPUT/OUTPUT MNEMONIC	CALIBRATION TYPE		
	RESPONSE	1-PORT	2-PORT
CALC01	$E_R$ or $E_T$	$E_D$	$E_{DF}$
CALC02		$E_S$	$E_{SF}$
CALC03		$E_R$	$E_{RF}$
CALC04			$E_{XF}$
CALC05			$E_{LF}$
CALC06			$E_{TF}$
CALC07			$E_{DR}$
CALC08			$E_{SR}$
CALC09			$E_{RR}$
CALC10			$E_{XR}$
CALC11			$E_{LR}$
CALC12			$E_{TR}$

" $E_{xx}$ " terms in these models are error terms, and the subscripts indicate the source of the error:

$$E_{xx}$$

First subscript

Second Subscript

D = Directivity

F = Forward

S = Source match

R = Reverse

L = Load match

X = Isolation (crosstalk)

R = Reflection signal-path tracking

T = Transmission signal-path tracking

Frequency Response  
Menu

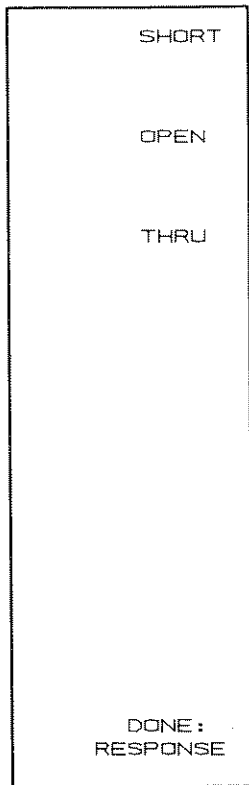

*Next Menu*

STANA

STANB

STANC

STAND

STANE

STANF

STANG

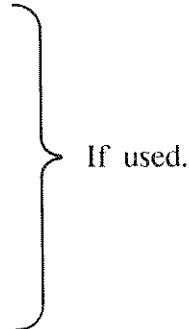

DONE → Cal Set Selection Menu

S<sub>11</sub> Cal Menu

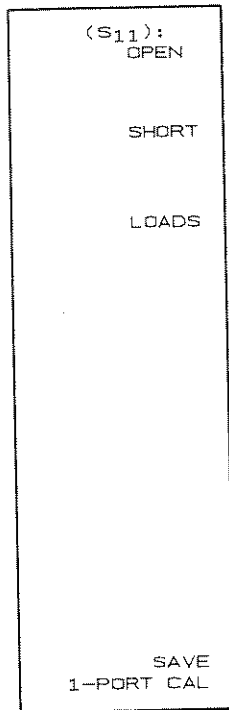

CLASS11A

CLASS11B

CLASS11C

SAV1

Cal Set Selection Menu

S<sub>22</sub> Cal Menu

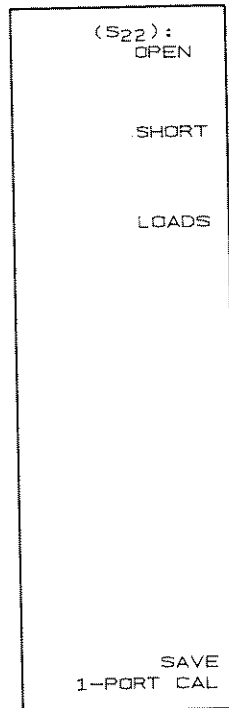

CLASS22A

CLASS22B

CLASS11C

SAV1

Cal Set Selection Menu

Loads Me

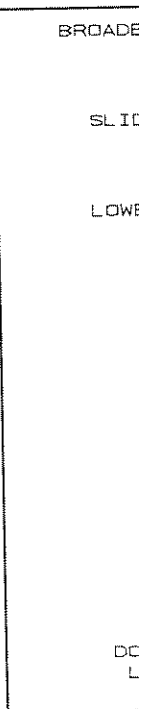

enu  
BAND  
ING  
BAND  
INE:  
LOADS



RT C

ASSI

ASSI

ASSI

EFD

WDT

WDM

RAE

One-Path 2-Port Cal Menu

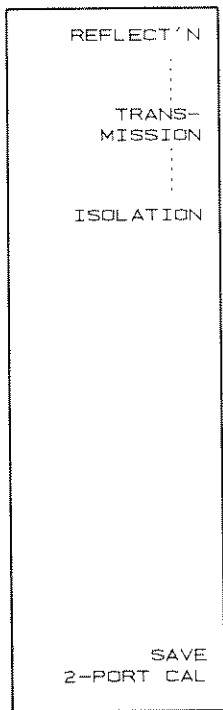

REFL

TRAN

ISOL

SAV2

Cal Set Selection Menu

S<sub>11</sub> Cal Menu

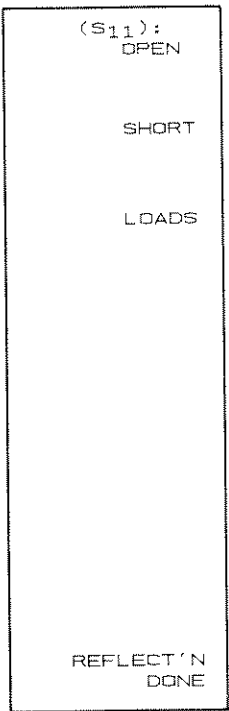

CL

CL

CL

RE

One-Path Isolation Cal Menu

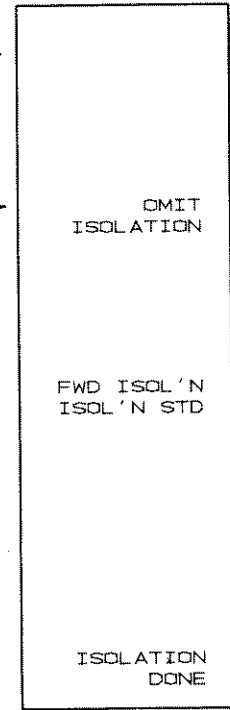

OMII

FWDI

ISOD

One-Path 2-Port Cal Menu

One-Path Transmission Cal Menu

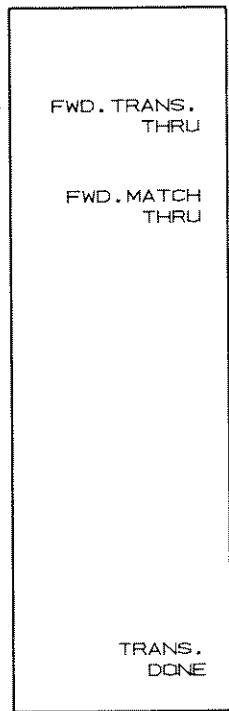

FV

FV

T

Modify Cal Kit  
Menu

DEFINE STANDARD
SPECIFY CLASS
LABEL CLASS
LABEL KIT
KIT DONE (MODIFIED)

DEFS \_\_\_\_\_

\_\_\_\_\_

\_\_\_\_\_

LABK → Title Menu

KITD → Cal Menu

Label Class Menu

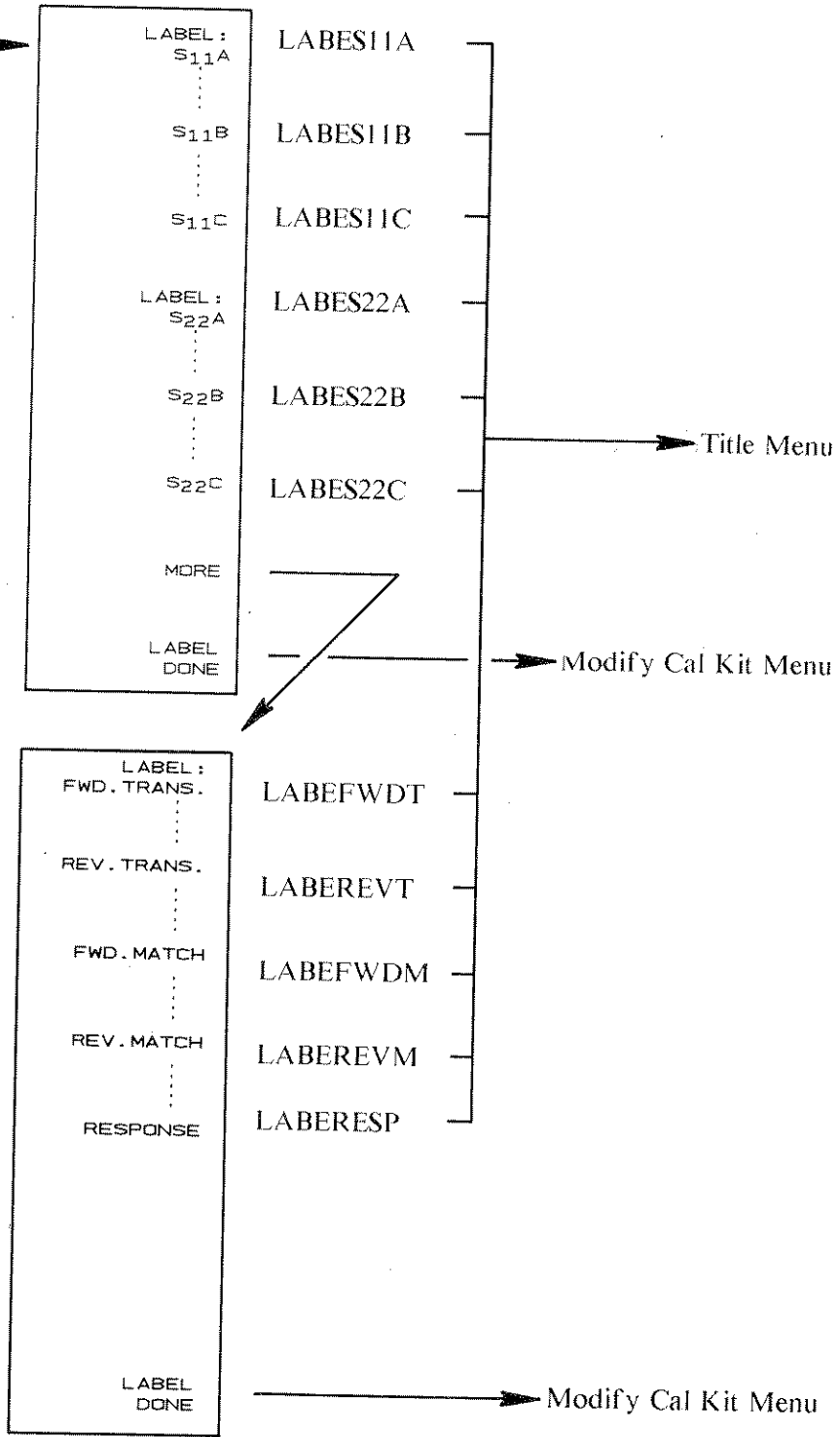

- Modify Cal Kit Menu

MODIFY CAL KIT  
MENU

Domain Menu

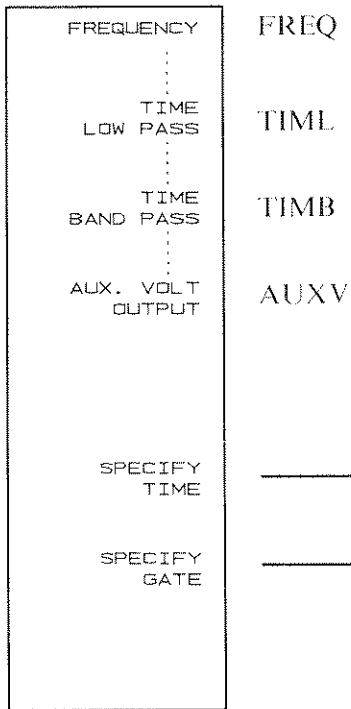

Set Frequency (Low Pass) Menu

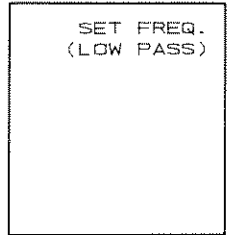

Specify Gate Menu

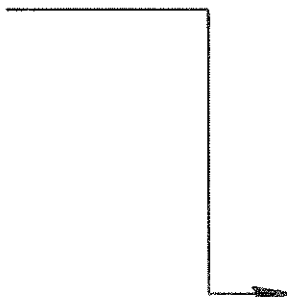
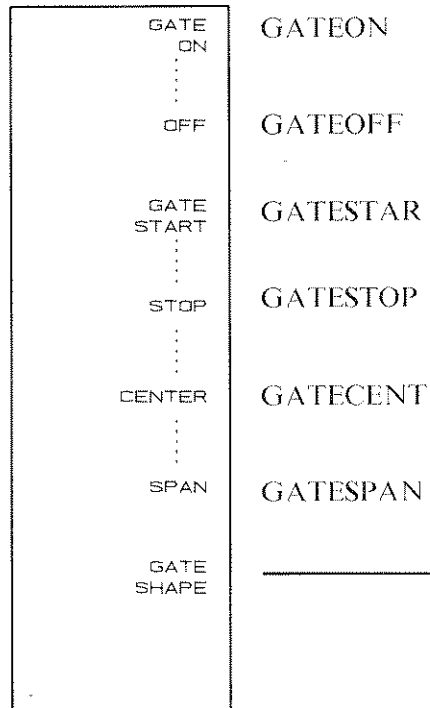



MEI

Menu

Display Menu

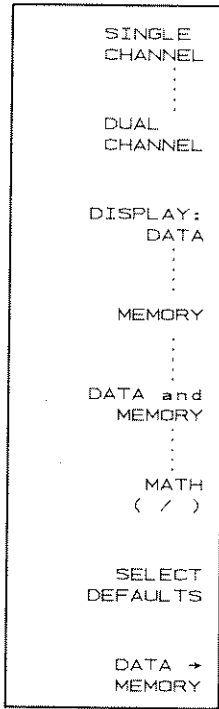

SINC

DISPDATA

DISPMEMO

DISPDATM

DISPMATH

DATI

Dual Channel Menu

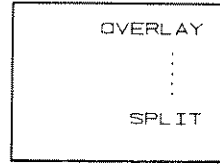

OVER

SPLI

Display M

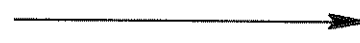

MARKER MENU STRUCTURE

Marker Menu

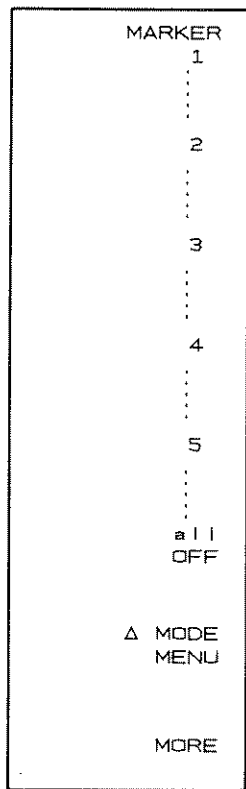

MARK1  
MARK2  
MARK3  
MARK4  
MARK5  
MARKOFF

Δ Mode Menu

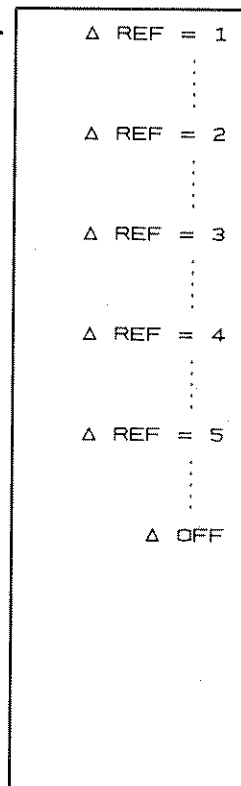

DELR1  
DELR2  
DELR3  
DELR4  
DELR5  
DELO

Marker Menu

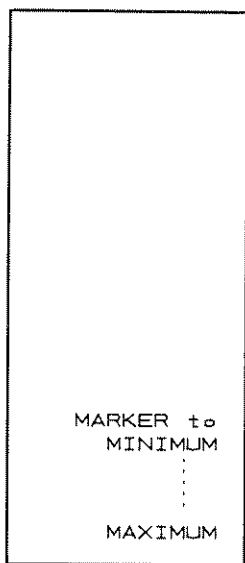

MARKMINI  
MARKMAXI

Copy Menu

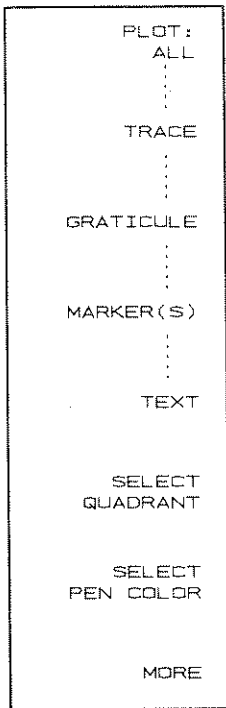

PLOTALL  
 PLOTTRAC  
 PLOTGRAT  
 PLOTMARK  
 PLOTTEXT

Plot Quadrant Menu

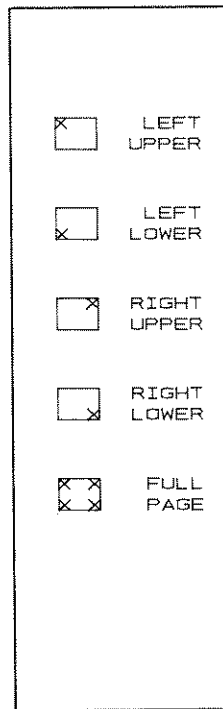

LEFU  
 LEFL  
 RIGU  
 RIGL  
 FULP

Copy Menu

Pen Selec Menu

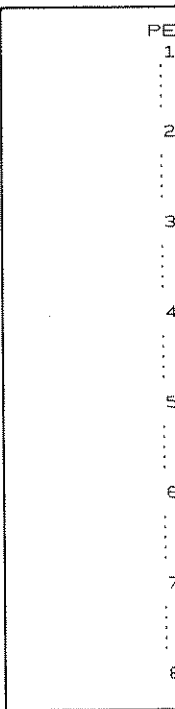

Operating Parameters Menu

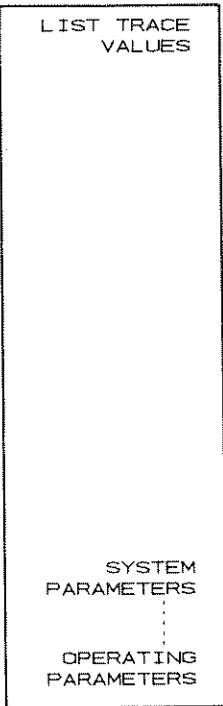

LIST  
 SYSP  
 OPEP

OPERATING PARAMETER	Channel 1	Channel 2
NUMBER of POINTS	201	201
SWEEP TIME	100.0 ms	100.0 ms
SOURCE POWER	10.0 dBm	10.0 dBm
POWER SLOPE	0.0 dB/GHz	0.0 dB/GHz
PORT 1 ATTEN.	0.0 dB	0.0 dB
PORT 2 ATTEN.	0.0 dB	0.0 dB
ELECTRICAL DELAY	0.0 s	0.0 s
PHASE OFFSET	0.0 °	0.0 °
IF AVERAGING FACTOR	1.0	1.0
SMOOTHING APERTURE	0.0 % SPAN	0.0 % SPAN
	OFF	OFF

N  
 RESTC  
 DISPL  
 PR  
 AMETE  
 PL  
 AMETE  
 P  
 AMET

Tape Menu

DIRECTORY
STORE
LOAD
DELETE
UN-DELETE
INITIALIZE TAPE

Initialize Tap  
Menu

INIT TAP? YES
NO

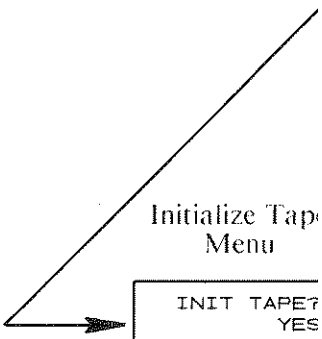

# TAPE MENU STRUCTURE

## Data Type Menu

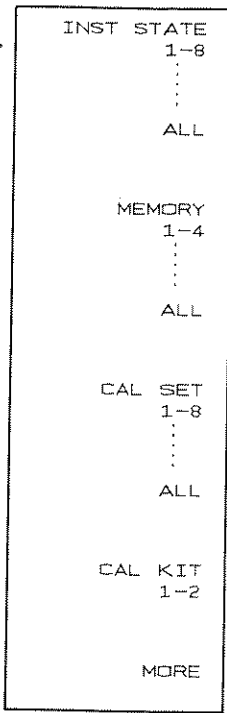

INSSALL

MEMOALL

CALSALL

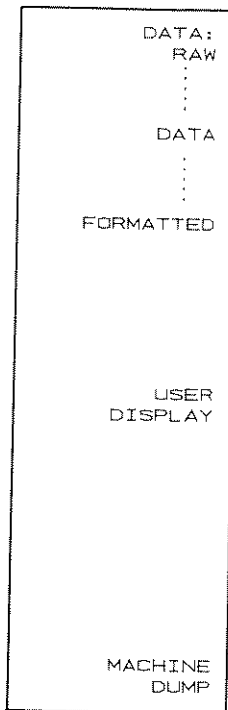

DATARAW

DATADATA

DATAFORM

USED

MACD

## Instrument State Selection Menu

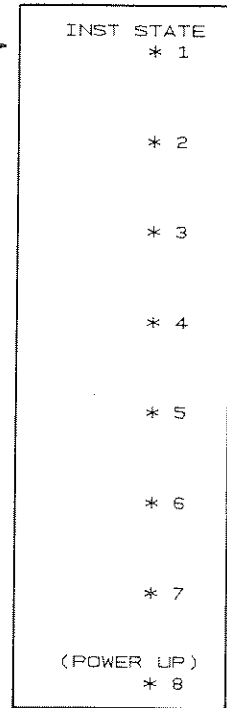

INSS1

INSS2

INSS3

INSS4

INSS5

INSS6

INSS7

INSS8

## Trace Memory Selection Menu

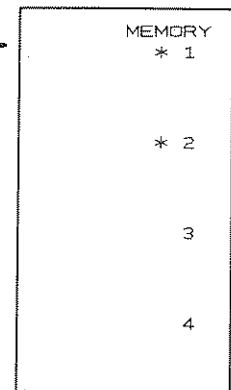

MEMO1

MEMO2

MEMO3

MEMO4

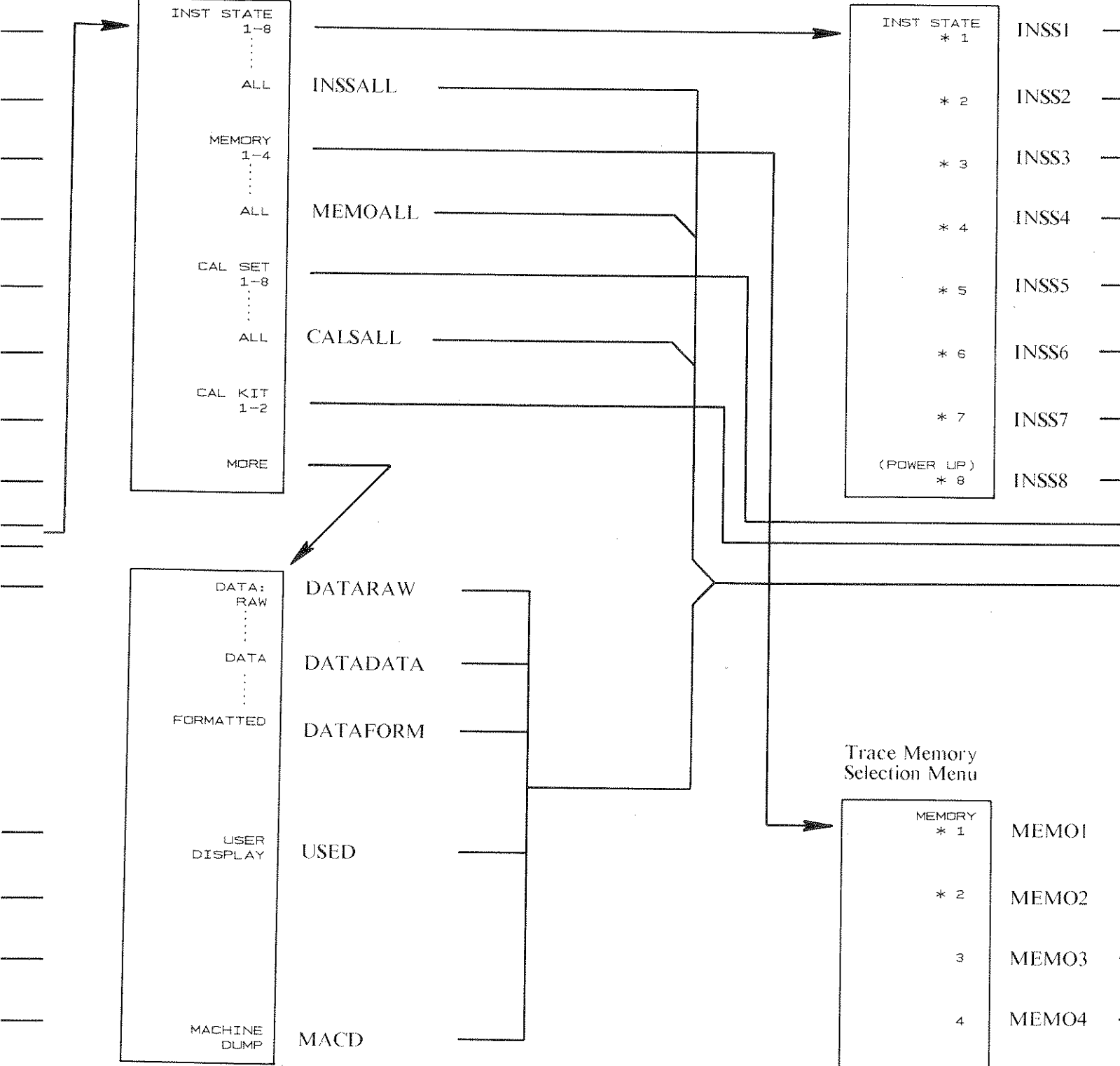

## FILE TYPES AND SIZE

8 files for each data type, 85 blocks each tape.

FILE TYPE	BLOCK SIZE
INSTRUMENT STATE 1-8	2
INSTRUMENT STATES ALL	13
MEMORY TRACE 1-4	1 2, if 401 points
MEMORY TRACES ALL	8
CAL SET 1-8	depends on cal type and number of points
CAL SET ALL	23
CAL KIT 1-2	1
RAW DATA	2 3, if 401 points
DATA	1 2, if 401 points
FORMATTED DATA	1 2, if 401 points
USER DISPLAY	2
MACHINE DUMP	58

**STORING INSTRUMENT STATES: SAMPLE SEQUENCE**

The following sequence illustrates how to save instrument states using the **TAPE** menu and the **SAVE/RECALL** menu.

Turn On Power (RECALL register 5 recalled)  
Press **PRESET** (Standard **PRESET** state recalled)  
Setup for measurement 1, **SAVE 1**.  
Setup for measurement 2, **SAVE 2**.  
Setup for measurement 3, **SAVE 3**.  
Setup for measurement 4, **SAVE 4**.  
Setup state you want after Power On, **SAVE 8**.

Check states:

**RECALL 1, 2, 3, 4, 8.**

Turn Off Power, Turn On Power.

(System recalls Instrument State stored in 8.)

To record, insert blank cartridge, then press:

**INITIALIZE TAPE,**

**INITIALIZE TAPE YES.**

**RECORD,**

**INST STATE ALL,**

**INST ALL FILE (select 1 - 8).**

**DIRECTORY.**

(The tape now contains states 1, 2, 3, 4, 5, 6, 7 and 8.)

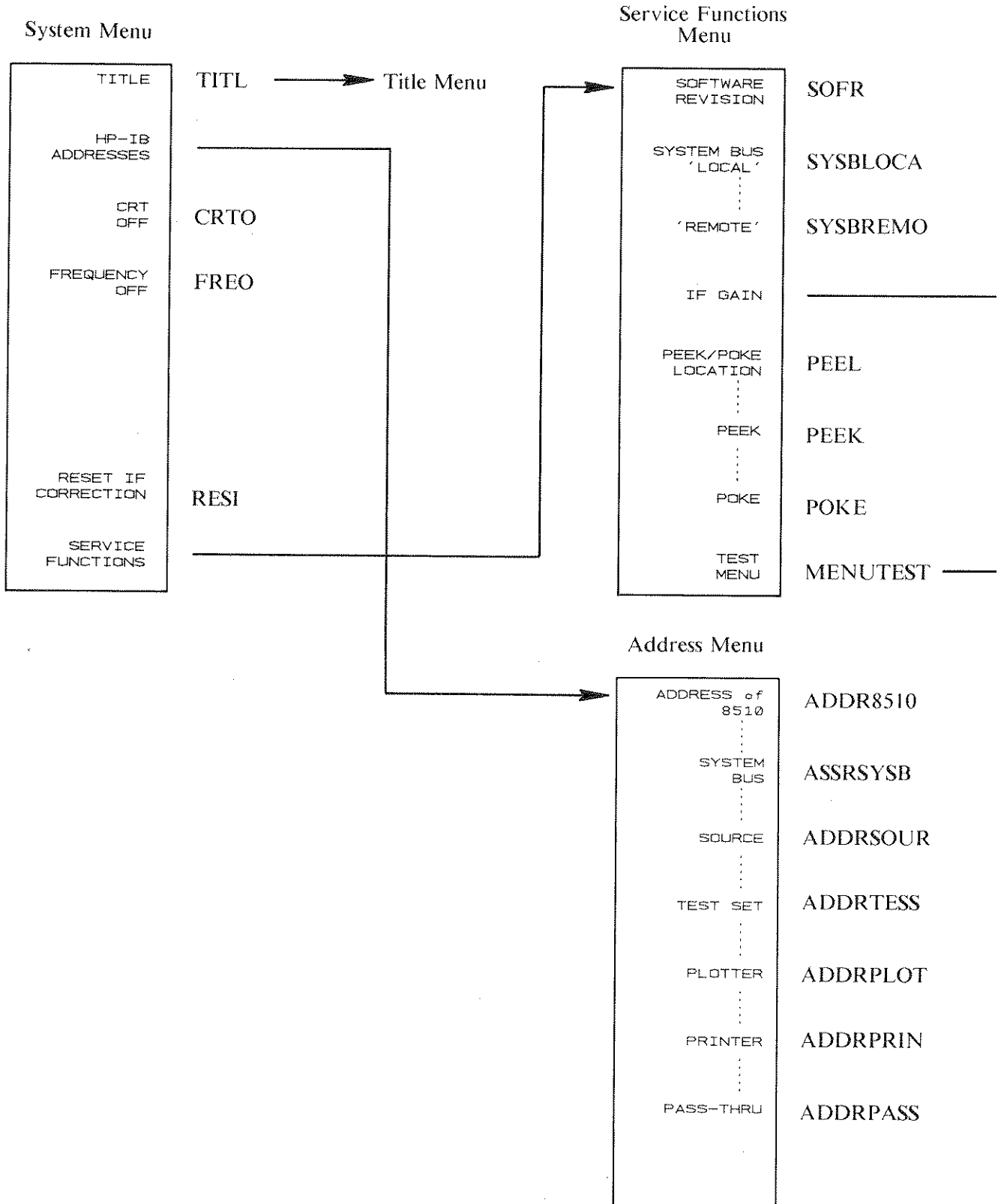



SAVE/RECALL MENU

Save Menu

INST STATE	SAVE1
* 1	
* 2	SAVE2
* 3	SAVE3
* 4	SAVE4
* 5	SAVE5
* 6	SAVE6
* 7	SAVE7
(POWER UP)	SAVE8
* 8	

Recall Menu

INST STATE	RECA1
* 1	
* 2	RECA2
* 3	RECA3
* 4	RECA4
* 5	RECA5
* 6	RECA6
* 7	RECA7
(POWER UP)	RECA8
* 8	



LOCAL MENU

Local Menu

ADDRESS of 8510	ADDR8510
SYSTEM BUS	ADDRSYSB
SOURCE	ADDRSOUR
TEST SET	ADDRTESS
PLOTTER	ADDRPLOT
PRINTER	ADDRPRIN
PASS-THRU	ADDRPASS

The Local Menu is identical with the Address Menu. To check or change an address, press the softkey and observe the address displayed in the Active Function area of the CRT. Use the knob, STEP keys, or numeric xI to change the address. For the source, test set, plotter, or printer the address becomes effective the next time the HP 8510 addresses the instrument.



TITLE MENU

	SELECT LETTER
<i>hp</i> POINT WITH KNOB; THEN PRESS 'SELECT LETTER'	
TITLE	
ABCDEFGHIJKLMNOPQRSTUVWXYZ.0123456789()+-*/=abmΓ12 ↑	SPACE
	BACK SPACE
	ERASE TITLE
	TITLE DONE



SERVICE SELECTIONS MENUService Selections  
Menu

SERVICE: TEST CAL	SERVTEC
REF CAL	SERVREFC
DETECTOR GROUND	SERVDETG
ADC GROUND	SERVADCG
VCAL	SERVVCAL
VREF	SERVVREF
TEMP. 1	SERVTEMP1
TEMP. 2	SERVTEMP2

**SERVICE SELECTIONS**

These selections are used in servicing the HP 8510 network analyzer system, and their use is explained in the Service section of the HP 8510 manual. Selections change the instrument state immediately. If you do not want to make a selection, press the front-panel key labeled **PRIOR MENU**. To clear any selection made from this menu, press the front-panel key labeled **PRESET**.





## HP-IB ONLY PROGRAMMING CODES

CLES	MONI	OUTPDATA
DEBUON	MENUOFF	OUTPERRO
DEBUOFF	MENUON	OUTPFORM
INPUCALC01	OUTPACTI	OUTPIDEN
INPUCALC02	OUTPCALC01	OUTPKEY
INPUCALC03	OUTPCALC02	OUTPMARK
INPUCALC04	OUTPCALC03	OUTPMEMO
INPUCALC04	OUTPCALC04	OUTPPLOT
INPUCALC05	OUTPCALC05	OUTPRAW1
INPUCALC06	OUTPCALC06	OUTPRAW2
INPUCALC08	OUTPCALC07	OUTPRAW3
INPUCALC09	OUTPCALC08	OUTPRAW4
INPUCALC10	OUTPCALC09	OUTPSTAT
INPUCALC11	OUTPCALC10	OUTPTITL
INPUCALC12	OUTPCALC11	SAVC
INPUDATA	OUTPCALC12	SOFT1
INPUFORM		SOFT2
INPURAW1		SOFT3
INPURAW2		SOFT4
INPURAW3		SOFT5
INPURAW4		SOFT6
KEYC		SOFT7
		SOFT8
		SQRM



## ERROR MESSAGES

When an error message appears, press ENTRY OFF or program OUTPERRO and read error number to clear message from CRT. All "Tell" messages are error number 0 (zero).

NUMBER	ERROR MESSAGE STRING
1	OPTIONAL FUNCTION, NOT INSTALLED Attempt to use option not available with current system. Time Domain Option not installed.
2	SYNTAX ERROR
3	INVALID KEY Pressed unlabeled softkey.
4	SOURCE SYNTAX ERROR
5	TEST SET SYNTAX ERROR
6	SYSTEM BUS ADDRESS ERROR Source or test set not connected to HP 8510 System Bus. Check address selection at instrument and check HP 8510 address assignments.
7	SYSTEM BUS SRQ ERROR
8	VTO FAILURE Pretune cycle not successfully completed. Possible causes are: Failure in VTO or summing amplifier. Bad IF Detector/Test Set interconnect cable.
9	NO IF FOUND Possible causes of no IF are: IF counter failure. Defective sampler. Weak VTO. Bad cable in IF path.
10	PHASE LOCK FAILURE Pretune has been accomplished but phase lock not achieved. Refer to Service procedures.

- 11 PHASE LOCK LOST  
Phase lock established then lost.  
Refer to Service procedures.
- 12 VTO OVERRANGE  
VTO swept beyond its normal range.  
Refer to Service procedures.
- 13 SOURCE SWEEP SYNC ERROR
- 14 IF OVERLOAD  
IF level is too high. Possible causes are:  
Source Power too high.  
Test Device Output level too high.
- In the normal ramp mode, the algorithm for autoranging the IF gain allows the gain to change 1 step at each point. If the response changes more than one IF gain step (about 15 dB) then the IF gain cannot follow the response and the message is issued to indicate a possible, but not definite, error. The error indication is displayed as an O symbol in the Enhancement Labels area of the CRT display.
- 15 ADC CAL FAILED  
The automatic calibration sequence for the Analog-to-Digital Converter has failed.  
Refer to Service procedures.
- 16 IF CAL FAILED  
The IF calibration is out of limits.  
Refer to Service procedures.
- 17 ADC NOT RESPONDING  
Power up message.  
Analog-to-Digital Converter not responding.  
Refer to Service procedures.
- 18 AUTORANGE CAL FAILED  
One or more of the IF gain steps out of limits.  
Refer to Service procedures.
- 19 SWEEP TIME TOO FAST  
Slow down the source Sweep Time.
- 20 UNABLE TO LOCK TO EXT 10 MHZ  
REFERENCE

- 21 NOT IMPLEMENTED IN SOURCE  
Requested function cannot be executed by source.
- 22 ERROR IN SAVING/STORING <INST. STATE/CAL SET/MEMORY>  
A write error has been detected while saving data into HP 8510 internal memory. If repeated attempts fail, service is required.
- 23 'NEW' CAL OR 'STORED' CAL REQUIRED
- 24 CURRENT PARAMETER NOT IN CAL SET  
The recalled cal set does not include the currently selected parameter.  
Correction is not turned on.
- 25 ADDITIONAL STANDARDS NEEDED
- 26 CORRECTION MAY BE INVALID.  
Cal Set Inst. State changed.  
Correction not turned off.
- 27 NO CALIBRATION CURRENTLY IN PROGRESS  
Attempted RESUME CAL with no cal in progress.
- 28 NO SPACE FOR NEW CAL  
Must DELETE CAL SET.
- 29 MORE SLIDES NEEDED
- 30 EXCEEDED 7 STANDARDS PER CLASS

31	NO <MEMORY/CAL SET/INST STATE> FOUND
32	ERROR IN RECALLING <MEMORY/CAL SET> Possible HP 8510 memory malfunction. If repeated attempts fail, service is required.
33	DATA OVERFLOW
34	ERROR IN DELETING CAL Same as 32.
35	NO PRINTER CONNECTED
36	PRINT ABORTED
37	NO PLOTTER CONNECTED
38	PLOT ABORTED
39	NO TAPE IN DRIVE
40	TEST SET IS TOO HOT
41	ATTEMPTED ILLEGAL TEST SET OPERATION
42	READ ATTEMPTED WITHOUT SELECTING OUTPUT TYPE
43	WRITE ATTEMPTED WITHOUT SELECTING INPUT TYPE
44	NOT USED
45	BLOCK ERROR INPUT
46	BLOCK INPUT LENGTH ERROR
47	FILE NOT FOUND
48	TAPE INIT ABORTED
49	COMMAND OUT OF SEQUENCE
50	FILE <STORE/LOAD/DELETE/ UN-DELETE> ERROR

- 51 FILE <STORE/LOAD/DELETE/  
UN-DELETE> ABORTED
- 52 LOAD ABORTED <data type> DATA  
MAY BE BAD
- 53 NO ROOM ON TAPE  
Current data type to be stored exceeds avail-  
able remaining tape blocks.
- 54 UNABLE TO LOAD <stored data number of  
points> POINTS  
Attempting to load DATA: <data type> stored  
with different number of points than current  
selection.
- 55 <tape format/tape drive/parity/write protect/  
checksum/unknown> ERROR
- 56 USING BACKUP DIRECTORY  
Transfer important data files to new tape.  
Primary tape directory error.
- 57 DIRECTORY NOT DISPLAYED
- 58 PARAMETERS NOT DISPLAYED  
Display System or Operating parameters before  
attempting page, plot, or print operations.
- 59 TURN <MEMORY/CORRECTION> OFF  
BEFORE LOADING FILE
- 60 LOAD ERROR. <data type> DATA MAY BE  
BAD
- 61 CAN ONLY LABEL USER PARAMETERS
- 62 CORRECTION AND DOMAIN RESET
- 63 ILLEGAL '101 KEY  
Keyboard error.
- 64 ILLEGAL '102 KEY  
Keyboard error.
- 65 REQUESTED DATA NOT AVAILABLE
- 66 INSUFFICIENT MEMORY

- 67            SYSTEM IS NOT IN REMOTE  
              Controller issued LOCAL. Non-remote-only  
              functions cannot be processed until controller  
              issued REMOTE.
- 68            COMMAND NOT IMPLEMENTED
- 69            CAL ABORTED (MEMORY  
              REALLOCATION)
- 70            TURN OFF CORRECTION AND/OR TIME  
              DOMAIN
- 71            CORRECTION RESET.  
              Correction turned off due to change in instru-  
              ment state.  
              See Cal Set Instrument State.
- 72            DOMAIN RESET  
              Domain changed from time to frequency due  
              to instrument state change. (Cal Set instrument  
              state, or turning correction on.)
- 73            INCONSISTENT WITH CURRENT  
              FORMAT  
              Attempt to use function which does not work  
              with current format.



### USER DISPLAY GRAPHICS

Instructions and data are sent to the HP 8510 User Display area of CRT display memory by setting the Pass Thru address to 31 (see ADDRESS of PASS THRU), then writing to the HP 8510 System Bus address (see ADDRESS of SYSTEM BUS).

mnemonic CS

Turn off Measurement Display.

mnemonic DF

Plotter Default Conditions.

Plotting mode	Absolute (PA)
* Relative character direction	Horizontal (DR1,0)
* Line type	Solid line
* Relative character size	HP 8510 Character Set
* Scale	Off
* Standard character set	HP 8510 Character Set
* Label terminator	ETX (ASCII decimal equivalent 3)
* Character slant	0 degrees

P1 and P2 are not affected by device clear and the default command (DF).

\* Cannot be changed by User.

mnemonic KP

Turn off User Display.

mnemonic LB

Label Instruction.

ASCII String Terminated with CONTROL C.

LB<string>t

Purpose: Draws the character string using the currently selected character set.

Parameters: <string> ASCII characters from HP 8510 character set (which may include control characters).

Terminator: t - label terminator defined by DF. Default is ETX, decimal 3.

mnemonic PA

Plot Absolute Instruction

PA  $x_1, y_1 [x_2, y_2 \dots x_n, y_n]$

or

PA;

Purpose: Plots to the X,Y coordinates in the order listed using the current pen up/down status. PA; sets absolute plotting.

Parameters: Pairs of integers representing plotter units if scaling not in effect, otherwise user units, integers or decimals.

$0 \leq x \leq 4095,$   
 $0 \leq y \leq 4095.$

mnemonic PD

## Pen Down Instruction

PD;

or

PD  $x_1, y_1$  [ $x_2, y_2 \dots, x_n, y_n$ ]

Purpose: Programmatically lowers the pen, then plots to the X,Y coordinates in the order listed. Parameters may be included as in PA or PR.

Parameters: Pairs of integers representing plotter units if scaling not in effect, otherwise user units, integers or decimals.

mnemonic PG

Clear (erase) User Display.

mnemonic PR

## Plot Relative Instruction

PR  $x_1, y_1$  [ $x_2, y_2 \dots, x_n, y_n$ ]

or

PR;

Purpose: Plots, in order, to the points indicated by the X,Y increments, relative to the previous pen position. PR; sets relative plotting for PU or PD with parameters.

Parameters: Pairs of integers representing plotter units if scaling is not in effect; otherwise user units, integers or decimals.

mnemonic PU

Pen Up Instruction

PU;

or

PU  $x_1, y_1$  [ $x_2, y_2 \dots, x_n, y_n$ ];

Purpose: Programmatically raises the pen.  
Parameters may be included as in PD.

mnemonic RP

Turn on user display.

mnemonic RS

Turn on measurement display.

**CIRCUIT MODELING PROGRAM MNEMONICS****STATEMENTS**

mnemonic **PORT**  
(50 ohm termination)

mnemonic **R**  
Resistance.

mnemonic **L**  
Inductance

mnemonic **C**  
Capacitance

mnemonic **TL**  
Transmission Line.

node1 node2 Z len Er series corfreq shunt

mnemonic **FREQ**

Frequency range.

fstart fstop numsteps

mnemonic **FREQ LOWPASS**

Set Time Domain Lowpass frequency range.

fstop numsteps

mnemonic **OUTPUT**

Send S-parameter data to HP 8510.

mnemonic **PLOT**

Plot data on Controller CRT.

#### NOTES

nnn represents a line number.

OUTPUT and PLOT can also be used as commands after the program has been RUN once.

The key [CLR I/O] interrupts an executing command and returns the program to user control.

## COMMANDS

mnemonic **CAT**mnemonic **DEL**mnemonic **GET**

filename

mnemonic **HELP**

[statement or command]

mnemonic **LIST**mnemonic **RUN**mnemonic **SAVE**mnemonic **PURGE**

filename

mnemonic **OUTPUT**

Snn

mnemonic **PLOT**

Snn [, Snn] ...

mnemonic END

mnemonic BYE

mnemonic EXIT

mnemonic QUIT